



**Choice and harmony
throughout the range!**



Contents

TECHNICAL DATA	4
MASONRY/ LINER	6
CONCRETE	8
PANEL/ LINER	10
POLYESTER SHELL	12
CHOICE & HARMONY	14
POSITIONING	15



BWT's range of

THROUGHWALL FLANGES, RETURN FITTINGS & VACUUM POINTS

TECHNICAL DATA:

Made in France, BWT's throughwall flanges, return fittings and vacuum points incorporate the latest technological innovations, quality and reliability are guaranteed.

The range comprises 4 versions: liner pools, traditional reinforced concrete pools, panel pools polyester shell pools.

Common features:

- Made of pool grade, UV stable ABS,
- Two sets of flange screw housings,
- Stainless steel screws, compatible with every pool type,
- Protective, adhesive work-site covers,
- Available in a range of colours,
- Made in France.



Vacuum
point RL-323



Return fitting
RB-310



Throughwall
flange TP-260



TECHNICAL DATA

BWT vacuum points and return fittings

UV-STABLE ABS

UV-stable, chemically inert ABS gives BWT throughwall flanges, return fittings and vacuum points a shiny, bright finish that doesn't fade over time under normal conditions of use.

INTEGRATED VACUUM POINTS AND RETURN FITTINGS.

No seal to be created between the throughwall flange and the return fitting or the vacuum point. Furthermore, the cost of a TP-260/270 or TP-261/271 throughwall flange is less than that of a conventional throughwall flange plus a return fitting or vacuum point..

THE BODIES OF THE FITTINGS ARE IDENTICAL *whether a "liner" or "concrete" version.*

In the event that a conventional pool fitted with BWT pool fittings develops a leak, a 1.5 mm reinforced membrane can be fitted with no difficulty. Concrete pool fittings can be transformed into Liner pool fittings by simply adding the necessary flange, gaskets and screws.

"LINER" MARKINGS

Tactile markers moulded into the body of each BWT return fitting and vacuum point help the installer easily locate the flange screw housings by touch under a liner or even under a 1.5 mm reinforced membrane..

WORK SITE PROTECTIVE COVERS

The self-adhesive work site covers delivered with each BWT throughwall flange, return fitting and vacuum point are intended to be fitted over the main drain to protect the body and the screw housings and stop them from being damaged or filled in with cement or concrete while the pool is being built.

SINGLE TYPE OF SCREW

All the screws required to fit a BWT return fitting or vacuum point are made of 18/10 stainless steel and are identical. Therefore it is easy to keep a supply in stock for future requirements..

AN INSERT FOR RENOVATION PROJECTS

Pool fittings with brass inserts are compatible with all types of pools: masonry/liner, concrete, panel, polyester shell, wooden pools and above-ground pools. If the pool is fitted with a 1.5 mm reinforced membrane, a 6 mm hole punch will be needed to accommodate the insert.

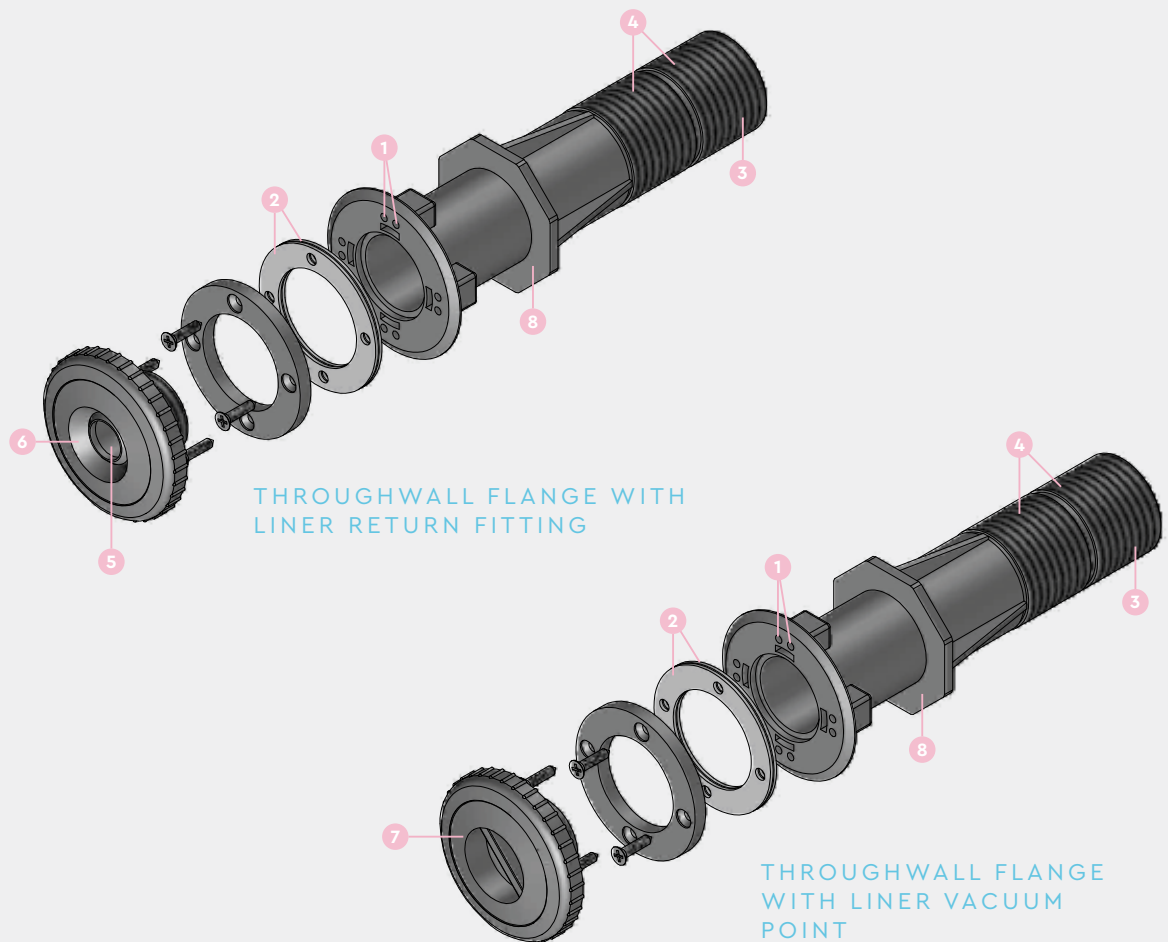

1 TWO SETS OF FLANGE SCREW HOUSINGS

The body of each BWT return fitting and vacuum point features two sets of flange screw housings. In the case of repetitive dismantling and reassembly required for the purposes of maintenance or repair, the screw housings can become deformed. Should that happen, the second set of screw housings can be used.

2 SELF-ADHESIVE SEALS

The liner versions of BWT return fittings and vacuum points come with 2 self-adhesive elastomer seals that are very easy to install and do not react with pool treatment chemicals.

3 2" THREADED AND FEMALE, SOLVENT, 50 MM

The rear of the BWT throughwall fitting can receive either a threaded 2" union or a 50 mm pipe (solvent).

4 TWO THREADED SECTIONS

The rear section of the 250 mm BWT throughwall fitting features 2 threaded sections so that it can adapt to the width of the wall. By cutting the first threaded section, the length can be reduced to 200 mm.

5 THE DIRECTIONAL JET DOES NOT PROTRUDE PAST THE POOL FITTING

The directional jet in BWT return fittings is housed inside the body of the fitting. It does not protrude into the pool and therefore poses no risk of injury to bathers. Return fitting jets are available in two sizes: 23mm et 12mm.

6 DIRECTIONAL JET BLOCKING MECHANISM

The collar that holds the directional jet is fitted with a device that prevents the directional jet from moving from its set position. The direction can be adjusted easily without dismantling the entire directional jet.

7 THE CAP DOES NOT PROTRUDE

The BWT vacuum point cap is housed inside the body of the fitting. It does not protrude into the pool and therefore poses no risk of injury to bathers.

8 ANTI-CAPILLARY COLLAR

BWT throughwall flanges are equipped with a collar that prevents water from travelling by capillarity along the body of the fitting. This feature is particularly appreciated in the case of traditional concrete pools.

Throughwall flange

MASONRY/ LINER

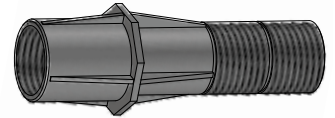

BWT TP-250

Code : 43600000 – Length 250 mm, tapped 2" and 50 mm solvent

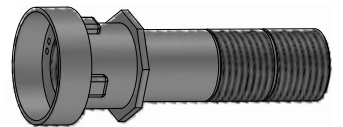
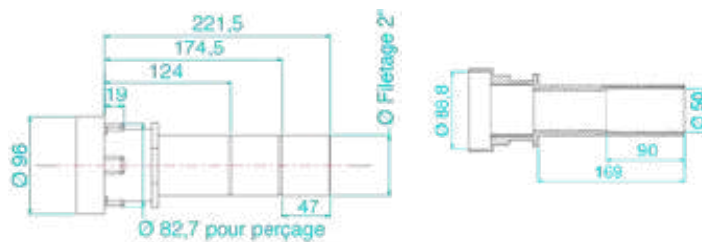

BWT TP-240

Code : 43000000 – Universal throughwall flange, 250 mm

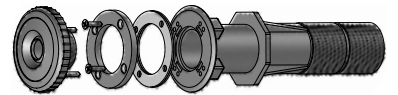
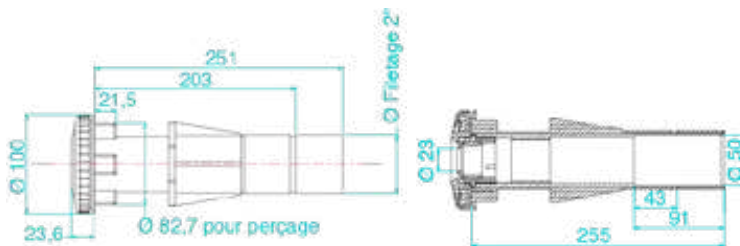

Light blue 43020081	Beige 43020085	Anthracite grey 43020087
Dark blue 43020082	Grey 43020088	Black 43020089

BWT TP-270

Code : 43020000 – Length 250 mm, with liner nozzle and directional jet

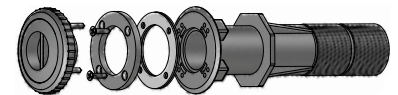
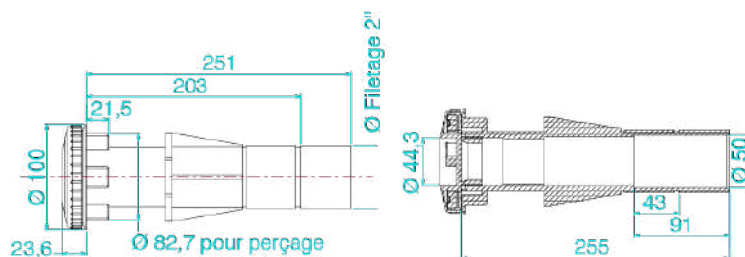

Light blue 43030081	Beige 43030085	Anthracite grey 43030087
Dark blue 43030082	Grey 43030088	Black 43030089

BWT TP-271

Code : 43030000 – Length 250 mm, with vacuum point and cap

Return fittings

MASONRY / LINER



BWT RL-311

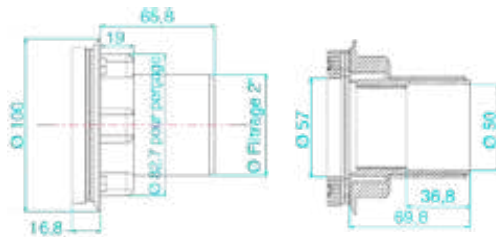

Code : 42000000 – Return fitting, liner

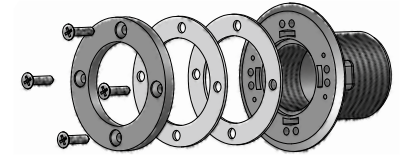

BWT RL-315

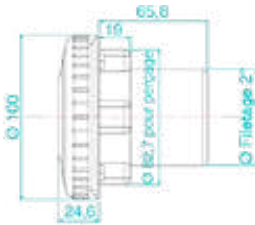

Code : 42030000 – Threaded 2" and 50 mm solvent, with jet orientable

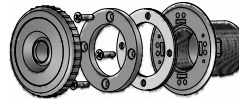

Light blue 42030081	Beige 42030085	Anthracte grey 42030087
Dark blue 42030082	Grey 42030088	Black 42030089



BWT RL-315-JO12

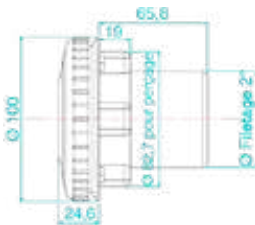

Code : 42225000 – Return fitting, liner, threaded 2" and 50 solvent, with 12 mm directional jet

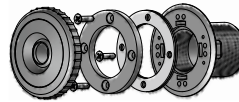

Return fittings 2" and 3"

MASONRY / LINER



BWT RL-319

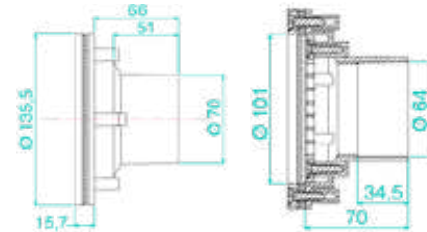

Code : 42010000 – With grating, 63 mm solvent

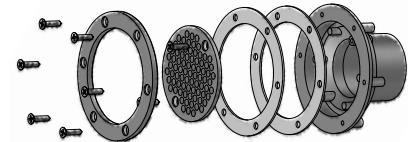

BWT RL-303

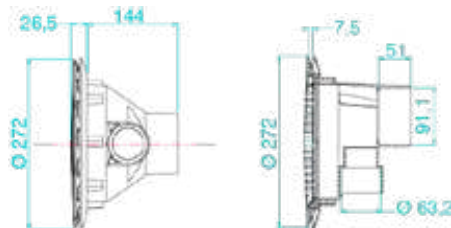

Code : 42020000 – With adjustable grating, 90 mm solvent

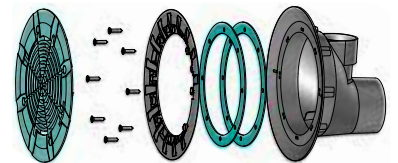

Vacuum point

MASONRY / LINER



BWT RL-323

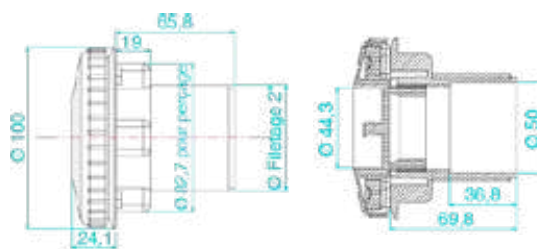

Code : 42060000 – With cap

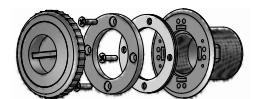

Light blue 42060081	Beige 42060085	Anthracte grey 42060087
Dark blue 42060082	Grey 42060088	Black 42060089

Throughwall flange

CONCRETE

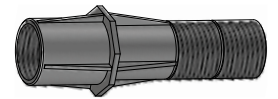

BWT TP-250

Code : 43600000 – Length 250 mm, tapped 2" and 50 mm solvent

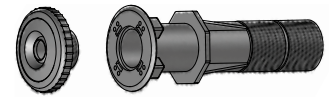
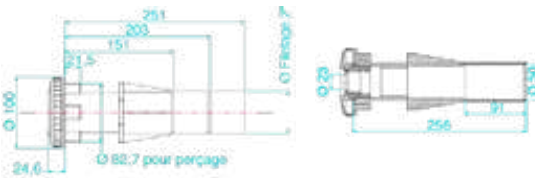

BWT TP-260

Code : 43620000 – Length 250 mm, with directional jet

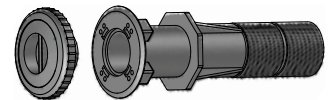
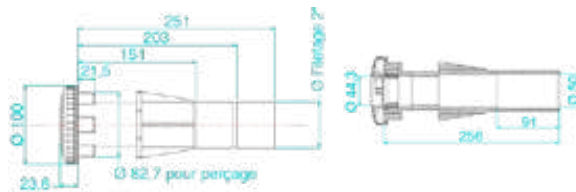

BWT TP-261

Code : 43630000 – Length 250 mm, with cap

Return fittings

CONCRETE

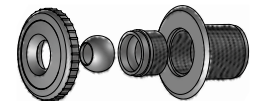
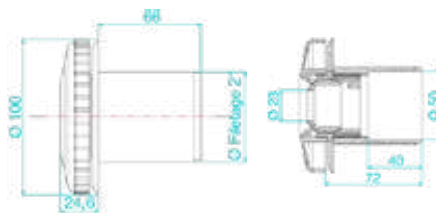

BWT RB-310

Code : 42630000 – Threaded 2" and 50 mm solvent, with directional jet

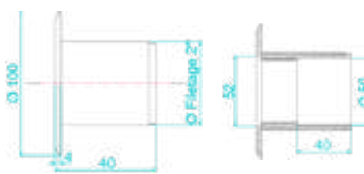

BWT RB-309

Code : 42600000 – Threaded 2" and 50 mm solvent, bare

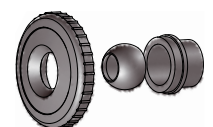
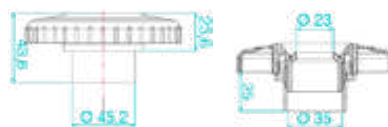

BWT RB-304

Code : 42635000 – Male, solvent, 40 mm, with directional jet
Glued into a 50 mm, PN-10, pipe

Return fitting 2" and 3"

CONCRETE



BWT RB-318

Code : 42610000 – With grating, 63 mm solvent

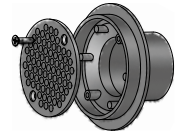
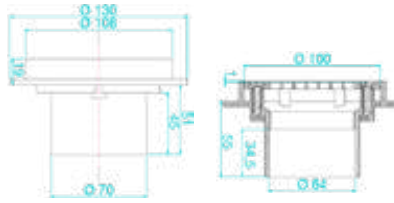

Vacuum point

CONCRETE



BWT RB-312

Code : 42660000 – With cap

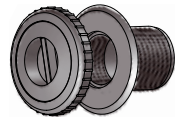
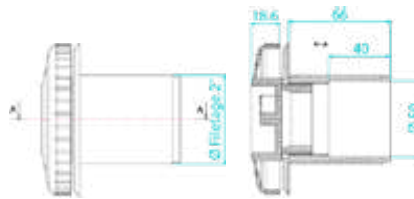



Return fitting

PANEL/ LINER



BWT RL-313

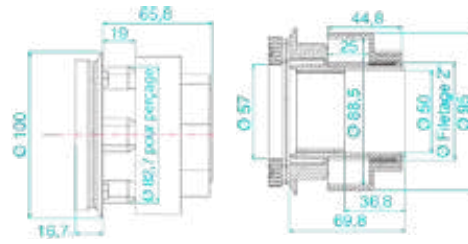

Code : 42200000 - With nut

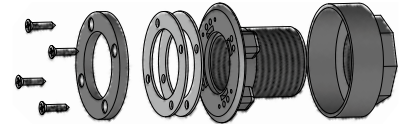

BWT RL-332

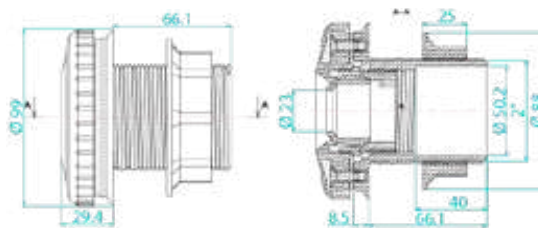

Code : 42231000 - With insert, jet and nut

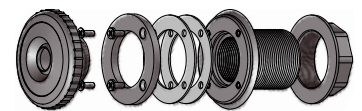

Beige 42231085	Anthracite grey 42231087
Grey 42231088	Black 42231089

Vacuum points

PANEL/ LINER



BWT RL-336

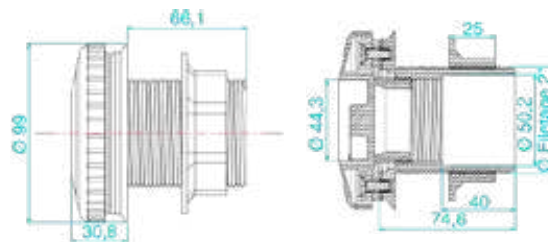

Code : 42261000 - With insert, cap and nut



Beige 42261085	Anthracite grey 42261087
Grey 42261088	Black 42261089

Return fittings

POLYESTER SHELL



BWT RL-327

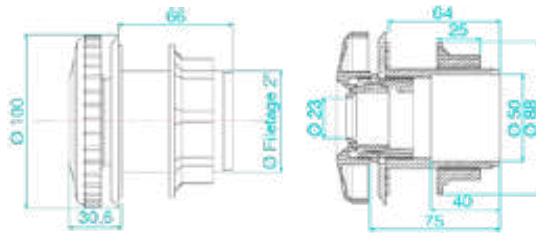

Code : 42430000 – 2" and 50 mm solvent, with lock nut and jet

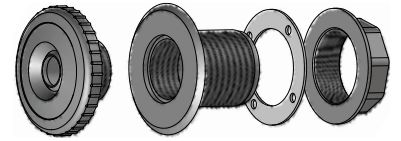

Vacuum point

POLYESTER SHELL



BWT RL-328

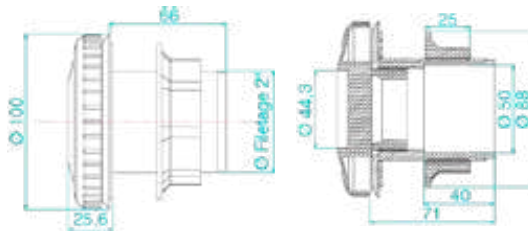

Code : 42460000 – 2" and 50 mm solvent, with lock nut and cap

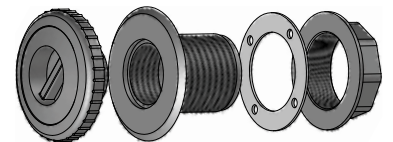

Anti-vortex wall suction point

POLYESTER SHELL



BWT PA-111-C

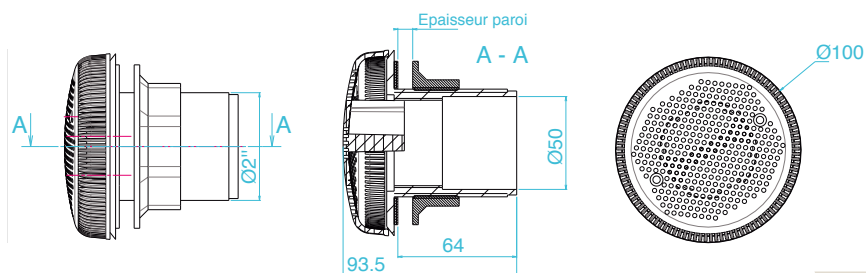

Code : 41400000 – with protective anti-vortex grating

Beige 41400085	Anthracite grey 41400087
Grey 41400088	



CHOICE & HARMONY

created with the BWT colour palette

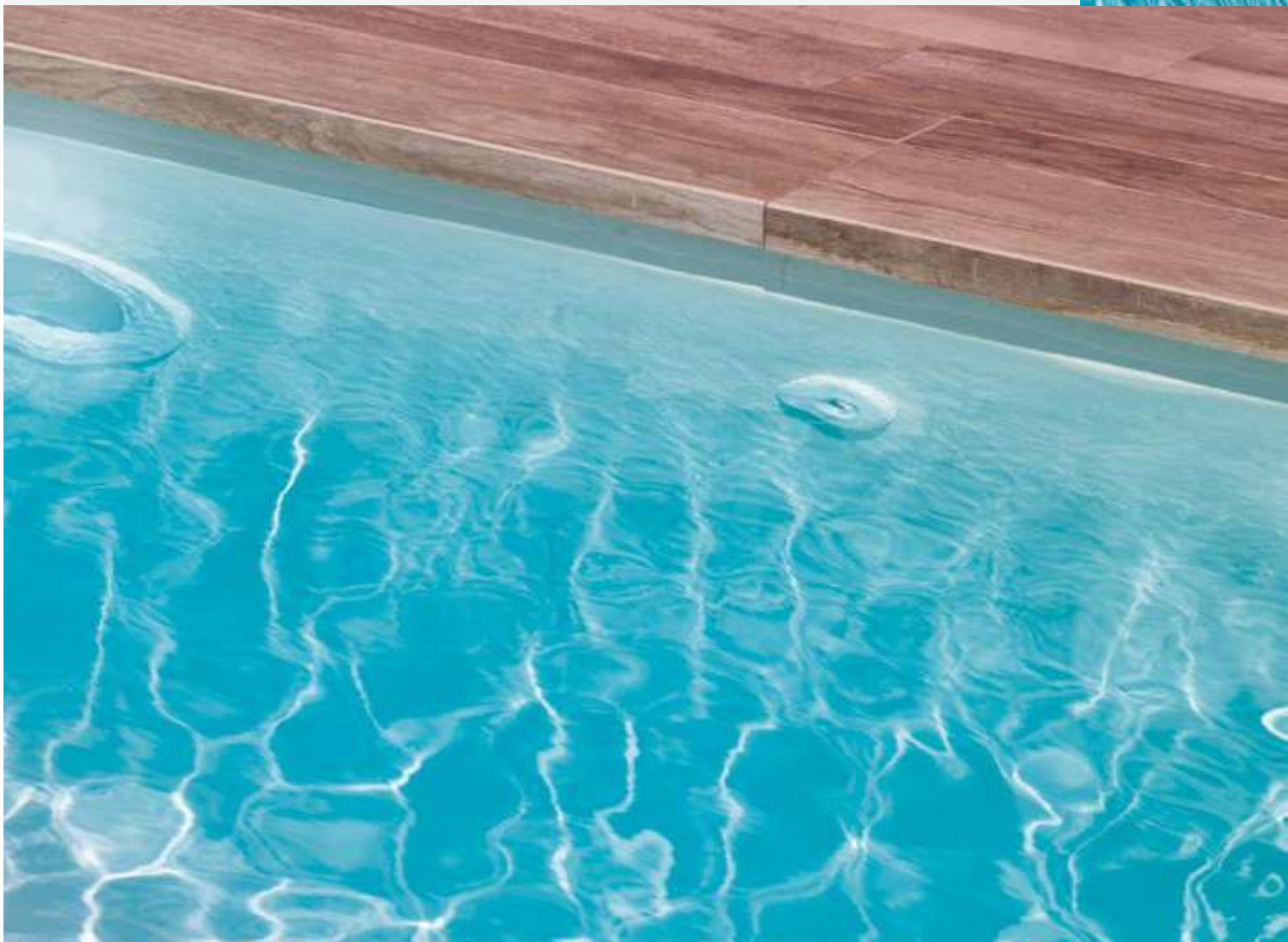



INSTALLATION OF A RETURN FITTING AND A VACUUM POINT

The diagrams below comply with DTP no. 8 of the FPP (Fédération des Professionnels de la Piscine – French federation of pool professionals)

THROUGHWALL FLANGE
with vacuum point

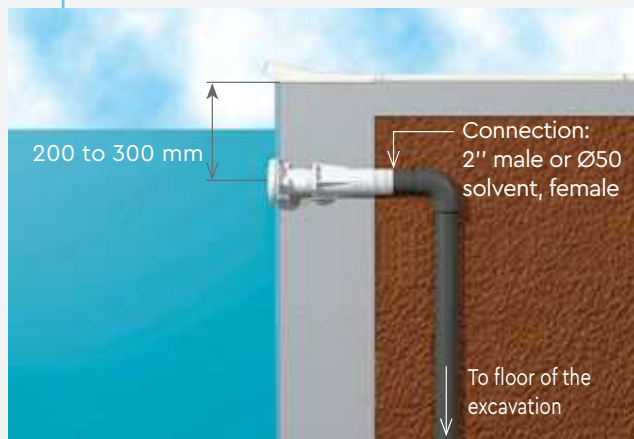

THROUGHWALL FLANGE
with return fitting

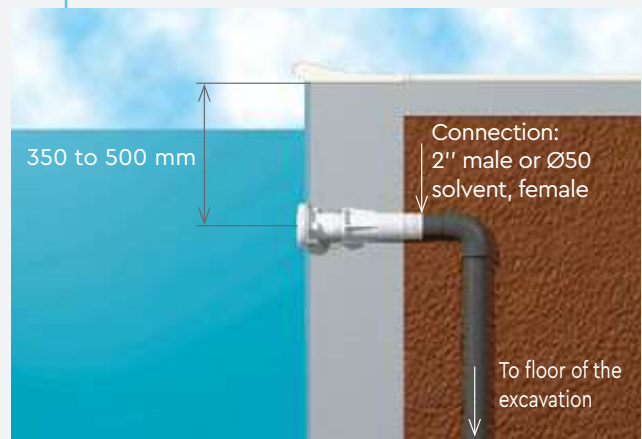



PROCOPI S.A.S.

Les Landes d'Apigné – B.P. 45328
35653 LE RHEU Cedex – FRANCE

☎ +33 2 99 14 78 78 📠 +33 2 99 14 59 05

✉ rennes@procopi.com

procoshop.com

Dealer's stamp:

A large, empty rectangular box with a thin black border, intended for a dealer's stamp or signature.