

HLVSP SERIES

VARIABLE SPEED PUMP MANUAL

HLVSP100Q
HLVSP150Q
HLVSP200Q

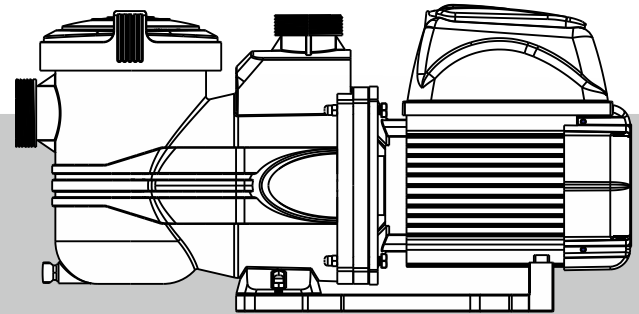

Please Read The Manual Carefully Before Use.

1 PRODUCT INTRODUCTION

HLVSP series pump is designed for the filtration of small and medium swimming pool, fountain, spa, aquaculture and water park.

2 PRODUCT BASIC PARAMETERS

Liquid Temperature: up to 50°C, Ambient temperature: 5~45°C.

2.1 TECHNICAL PARAMETERS TABLE

Model	Max. Flow (m ³ /h)	Max. Head (m)	Horse power (HP)	RPM (r/min)	Input power (kW)	Connection size (inch)	Voltage (V)
HLVSP100Q	27	14.5	1	1000-2900	0.9	2	220
HLVSP150Q	30	16	1.5	1000-2900	1.3	2	220
HLVSP200Q	33	17	2	1000-2900	1.8	2	220

2.2 Q-H CURVE

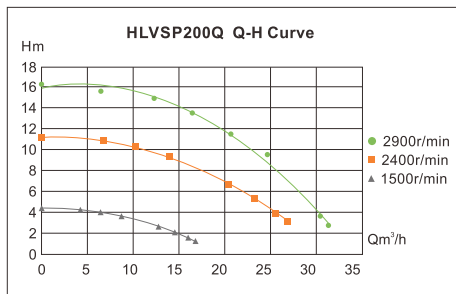
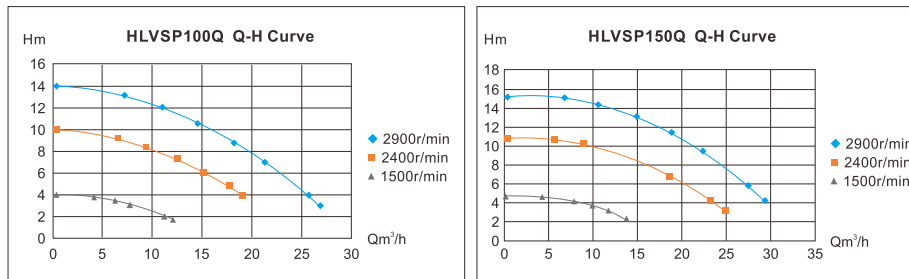

.1.

3 PRODUCT OPERATION INSTRUCTION

Control panel.

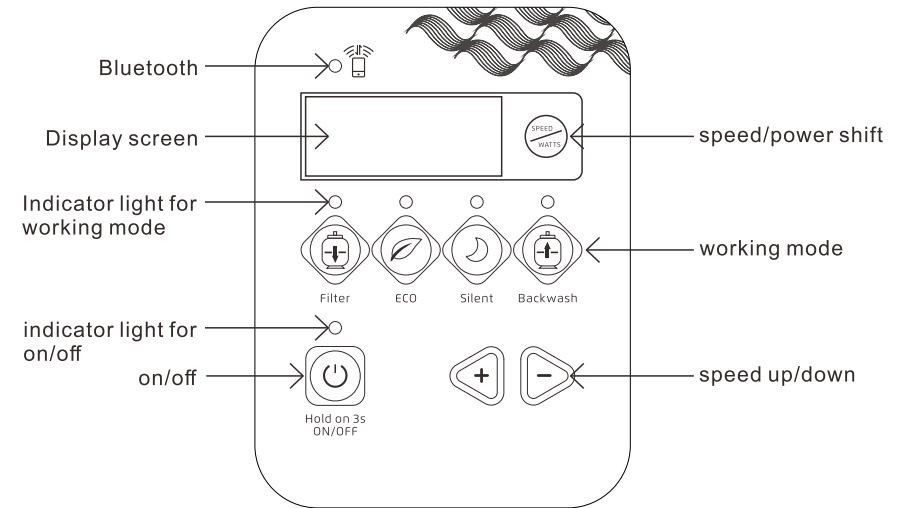

3.1 DISPLAY SCREEN

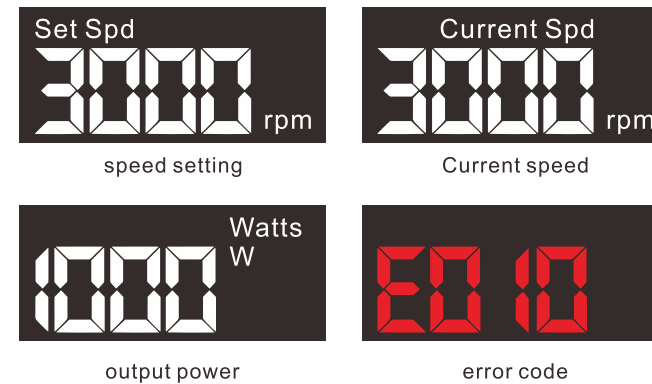

.2.





3.2 INDICATOR LIGHT

Indicator light	Description
Bluetooth indicator is always blue	The pump has been connected to the mobile phone App via Bluetooth.
The Bluetooth indicator flashes	The water pump enters the pairing mode.
APP Bluetooth indicator is off	The pump is not connected to the mobile phone App.
The current mode indicator is always white	The pump is running in the mode corresponding to the indicator.
The current mode indicator is off	The pump is running at a customized speed.
Power indicator is always white	The pump is running.
Power indicator is always red	The pump is in standby state.



3.3 PUMP FUNCTION AND CONTROL KEYS

working mode:

There are 4 pre-set working mode, they are Filter, ECO, Silent and Backwash.

working mode	Description
Filter 	The pump's speed will be converted to 2900r/min within 40 seconds.
Silent 	The pump's speed will be converted to 2600r/min within 40 seconds.
ECO 	The pump's speed will be converted to 2400r/min within 40 seconds.
Backwash 	The pump first runs at 3300r/min for 15s and then falls back to 2400r/min.

Speed adjustment function:

Short press "", the speed will be increased or decreased by 50r/min; Long press "", the speed will be increased or decreased by 100r/min.

Speed/power shift:

Press "", the screen will show the current speed and output power.

On/off:

Long press "" for 3s, the pump will be on or off.

Self-priming:

After the pump starting, it will self-prime 1 minute at a speed of 2900 rpm, and then enters to preset mode or custom speed after 1 minute.

Bluetooth:

Create the group in App, set the speed of any pump in the group (by App or control panel), and the other pumps in the group will automatically synchronize the running status.

Factory reset:

Simultaneously press and hold button "" for 10 seconds, the indicator will flash 2 times and accompanied by 2 beeps. Factory reset succeeded.

3.4 APP DOWNLOAD SITE

Users can search for "MegiFlow" in the Apple Store and Google Play to download the app or scan the QR code below to obtain the app.



Android



IOS

3.5 APP FUNCTION

App add equipment:

Simultaneously press and hold button "" for 10s, After restoring factory setting, the pump will automatically start the pairing mode, then click the "+" of the App to add the pump.

App remove equipment:

On the APP main page, long press the icon of pump for 3s, the pump can be removed after the deletion interface pops up.

Edit Group:

Open the App group page, you can edit multiple pumps to the same group (only operate when the device is online, otherwise the operation will fail). After the grouping is completed, control any pump in the group, and the other pumps in the group will automatically synchronize the running status.

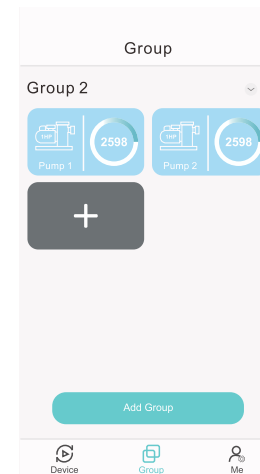

Cancel the group:

On the App group page, you can press and hold the pump device to delete unwanted pumps in the group.

Edit the schedule:

On the schedule page, you can set the scheduled task of the pump(only operate when the device is online, otherwise the operation will fail).

When the set time is reached, the pump will automatically run in the corresponding set mode.

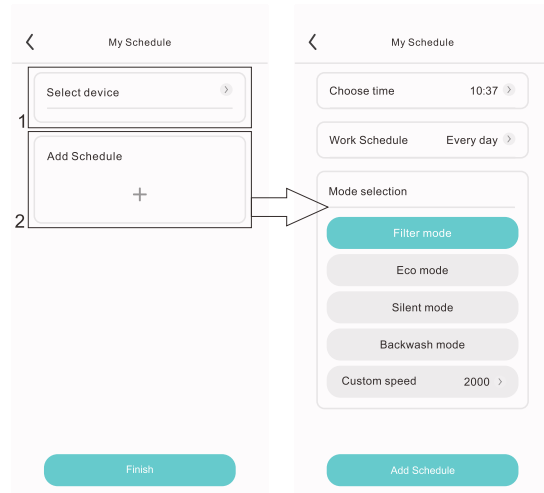

Cancel/revise the schedule:

On the App page, you can modify the timing--scheduled task of the pump (only operate when the device is online, otherwise the operation will fail).

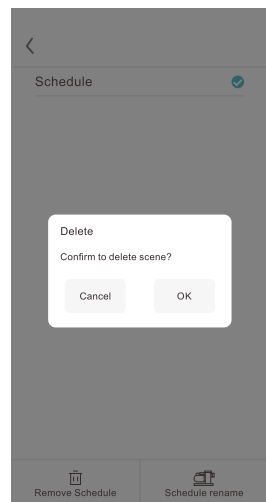

.5.

Power on setting:

Click the pump icon in the APP and enter the operation page, then click "more" icon in the upper right corner and select the "power on to perform actions".

Power on standby: if the pump accidentally power off and then restart, it will be in standby state.

Power on start: if the pump accidentally power off and then restart, it will automatically restores to the mode before power off.

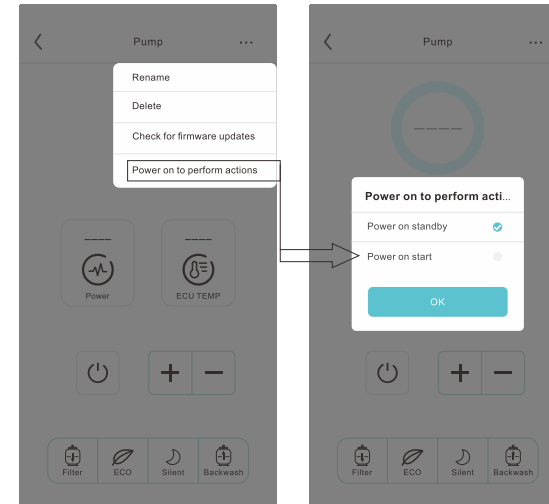

4 PRODUCT STRUCTURE AND DIMENSIONS

4.1 CONNECTION SIZE (INLET/OUTLET)

The pump comes with 2" connection. The user can use water pipe adapters to match different sizes of pipes.

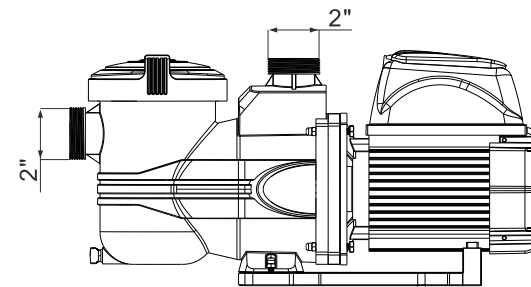

.6.

4.2 PRODUCT DIMENSION

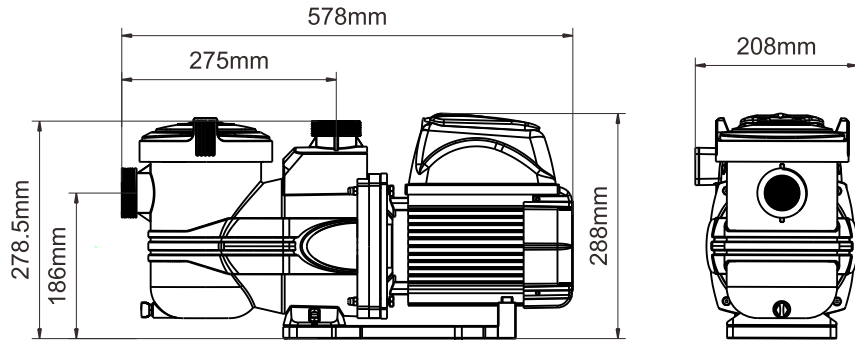

5 INSTALLATION

1. The pump needs to be installed on a flat and solid surface and fixed with hex bolts.
2. The pump inlet and outlet must be aligned with pipes, and there should be no misconnection.
3. The pump outlet pipe needs to install check valve.
4. The pump inlet and outlet pipes should be fixed to avoid damage to the pump caused by the vibration of the pump.
5. The pump cannot be installed above the water surface 2M.
6. Sufficient space should be reserved around the water pump for water discharge.

6 TROUBLE SHOOTING

Error code	Reason of Error	Remark & Solution
E01	overvoltage protection	Pump input voltage too high, check the power supply
E02	Low voltage protection	Pump input voltage too low, check the power supply
E03	over temperature protection	The pump internal temperature overheat, and the over-temperature protection activated, check the operating environment.
E04	Phase failure	Motor not start, check motor internal wiring if wrong connection or loosen
E05	Start up failure	Motor failed to start, check circuit if normal. The pump motor failed to start normally after repeating 5 times, maybe the motor or the driving circuit is abnormal. (Instantaneous current overcurrent, IPM Fo, excessive field-weakening input, current sampling circuit failure.)
E06	Water shortage protection	The water pump is idling. Check whether water intake is blocked or the water inlet valve is not open.
E07	Placeholder	—
E08	Overload protection	The water pump runs abnormally and the overload protection starts, check the water pump
E09	OTA upgrade failure	OTA upgrade failed. Please check the network and upgrade again
E10	Internal temperature sensor invalid	Internal temperature sensor failed
E11	Keypad failure	The pump key panel is malfunctioning, check whether the pump internal wiring is loose
E12	PFC module abnormal	The pump is failure. Please contact the service for maintenance.

7 PRECAUTIONS

1. The wiring must be correctly configured according to the wiring diagram indicated in the specification, and wrong wiring may lead to safety accidents.
2. Please avoid using under the following environmental conditions:
 - (1) Environment with severe vibration.
 - (2) Near flammable objects.
 - (3) In an environment prone to condensation, in an environment with a relative humidity of 90% or more.
 - (4) Please do not store the product with external force or heavy load, and do not place heavy objects on the product, otherwise it may cause damage to the appearance of the product or damage to the device .
3. Please avoid storing in high temperature and humid places. It's recommended to store the product with a humidity of 40-60%RH and a temperature of 20-30°C for a long-term storage.
4. In case of an error, please refer to the error code prompt for troubleshooting. If you still cannot solve it, please contact the salesman.