

# Installation & Operation Manual

## Swimming Pool Heat Pump

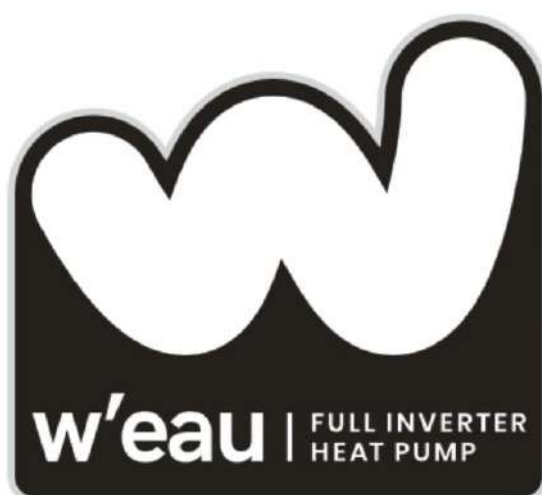

**Model No.: WFI-007/010/013/017/021**

Thank you very much for purchasing our product, please keep and read this manual carefully before you install heat pump.

---



### **Fluorinated greenhouse gas – (R32)**

The device contains the fluorinated greenhouse gas (R32) which is required for the device to work.

Industrial designation                      HFC-32

Common designation                        R32

Global warming potential (GWP)        675

Further information can be found on the device itself or the Specifications.

#### **WARNING!**

##### **Risk of fire and explosion through leaking finned heat exchanger!**

The refrigerant circuit of the finned heat exchanger contains highly pressurised, easily flammable, odourless gas. Risk of fire and explosion in the event of uncontrolled gas leakage.

- Action of filling gas must be conducted by professional with R32 operating license.
- Keep the heat pump away from heat sources and naked flames.
- Do not drill into or scorch the heat pump.
- Do not use any objects apart from those permitted by the manufacturer to speed up the defrosting process.
- Immediately shut off the heat pump if you suspect a gas leakage.
- The refrigerant is odourless. Always keep ignition sources away from the installation site of the heat pump.
- Contact an authorized expert if you suspect a gas leakage.

#### **WARNING!**

##### **Risk of electric shock!**

A faulty electrical installation or a mains voltage that is too high can lead to electric shock.

- Have the installation, initial start-up and maintenance of the heat pump carried out by authorized technician only.
- Please always cut the power supply if you want to open the cabinet to reach inside the heat pump as there is high voltage electricity inside.
- Only start work on the heat pump after checking all safety regulations.
- Only connect the heat pump if the mains voltage from the power socket matches the voltage indicated on the rating plate.
- Do not operate the heat pump if there is visible damage or the mains cable or the mains plug is defective.
- Do not open the housing. Leave repairs to qualified specialists. Liability and warranty claims are

excluded in the event of repairs carried out on your own, improper operation.

- Ensure that children do not insert any objects into the fan blade and heat pump.
- Ensure that the electrical system to which the heat pump is connected has an earth conductor.
- If the unit would be installed where is vulnerable to lightning stroke, lightning protection measurements must be carried out.

 **ATTENTION!**

- The manufacturer declines any responsibility for the damage caused with the people, objects and of the errors due to the installation that disobey the manual guideline. Any use that is without conformity at the origin of its manufacturing will be regarded as dangerous.

- Please always keep the heat pump in the ventilation place and away from anything which could cause fire.

- Don't weld the pipe if there is refrigerant inside machine. Please keep the machine out of the confined space when make gas filling by the authorized technician.

- Please always empty the water in heat pump during winter time or when the ambient temperature drops below 0°C, or else the Titanium exchanger will be damaged because of being frozen, in such case, it will be out of warranty for this machine.

- Please well keep the display controller in a dry area to protect the display controller from being damaged by humidity.

## Content

<b>Accessories description.....</b>	<b>3</b>
<b>Attention for safety.....</b>	<b>4</b>
<b>Installation of the unit.....</b>	<b>5</b>
<b>Specifications.....</b>	<b>9</b>
<b>Electrical Wiring.....</b>	<b>10</b>
<b>Instruction of operation .....</b>	<b>12</b>
<b>Adjusting and Initial operation.....</b>	<b>18</b>
<b>Operation and maintenance.....</b>	<b>19</b>
<b>Error codes &amp; Solutions.....</b>	<b>21</b>
<b>WiFi-Function.....</b>	<b>23</b>

# 1. Accessories description

Each unit produced by our factory is with the following accessories:

No.	Name	Qty.	Use
1	Instruction Manual	1 PC	Guide users to install the system
2	Drain-pipe	1 PC	Used for draining the condensate water
3	Drain-pipe connector	1 PC	Connect the drain pipe to the heat pump unit
4	Rubber shock absorber	4 PCS	Reduce vibration and reduce noise
5	Heat pump unit	1 SET	For heating water
6	Water connection	2 SET	Connect the piping system

For function you need to purchase at least the following parts for each unit:

No.	Name	Qty.	use
1	Water pump	1	Cycle the heated water
2	Filter system	1	Protect the heat pump from pool water
3	Water pipes system	1	Connect the equipment and make circulation

## ⚠ NOTE

The types and quantity of the water pipes, valves, filter equipment, sterilizing equipment which used for the swimming pool heating/circulation pipe system, depend on the project design.

We suggest not to install auxiliary electric heaters in the system. If must install auxiliary electric heaters, it should be operated by the specialized persons, and our company has no responsibility for all the problem cause by the auxiliary electric heater.

## Illustrations of machine

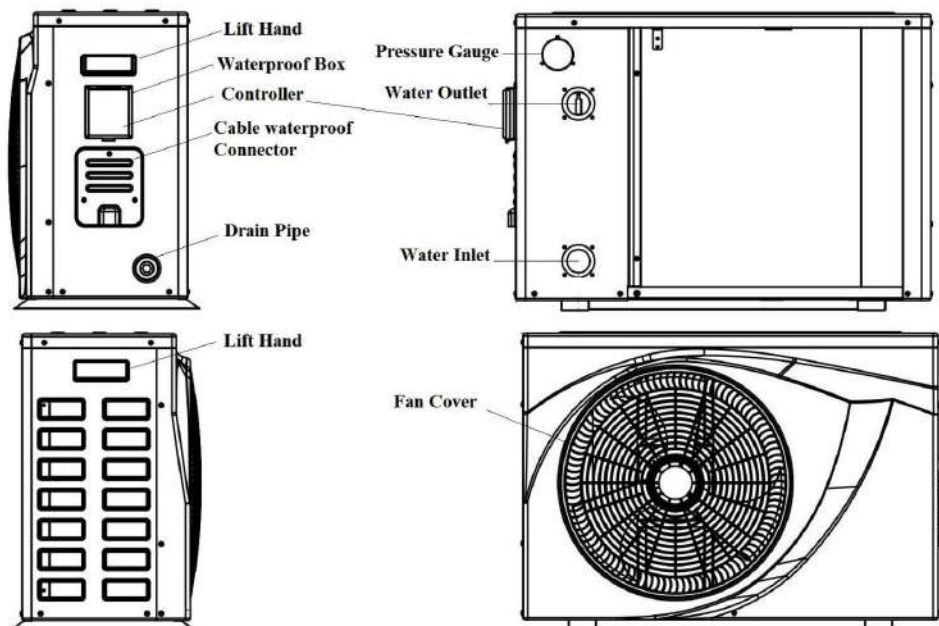

## 2. Attention for safety

### Range of application:

1. Power supply: 220~240V/1N~50/60Hz.
2. Environment temperature: -15°C~43°C
3. Water temperature range: 8°C~40°C in Heating function  
8°C~28°C in Cooling function

- Confirm the ground connection, if the ground connection is not correctly done, it may cause electric shock. And please cut off the power in the lightning storm weather.



- If install the heat pump in a small room, it must keep good ventilation.
- The main power switch should be out of the reach of Children.
- Don't put finger or stick into the air inlet or air outlet as the high-speed rotor may cause injury.
- When an exception happened (burning smell etc.), turn off the manual power switch immediately and contact with after-sale service department.
- When the unit needs to be removed or re-installed or repaired, please entrust after-sale service department and specialized personnel to do it. If the installation/ maintenance is not well done, it may cause unit operation failure, electric shock, fire, hurt, leaking, etc.
- Must not be unauthorized reformed, otherwise it may cause electric shock or fire.
- Must not install the unit with combustible around.
- Confirm the installation base is strong enough to avoid falling of the heat pump.
- Confirm leakage protection switch is installed to avoid electric shock or other issues.
- When cleaning the unit, the operation should be stopped, and power switch should be turned off.

# 3. Installation of the unit

## 3.1 Installation Illustration

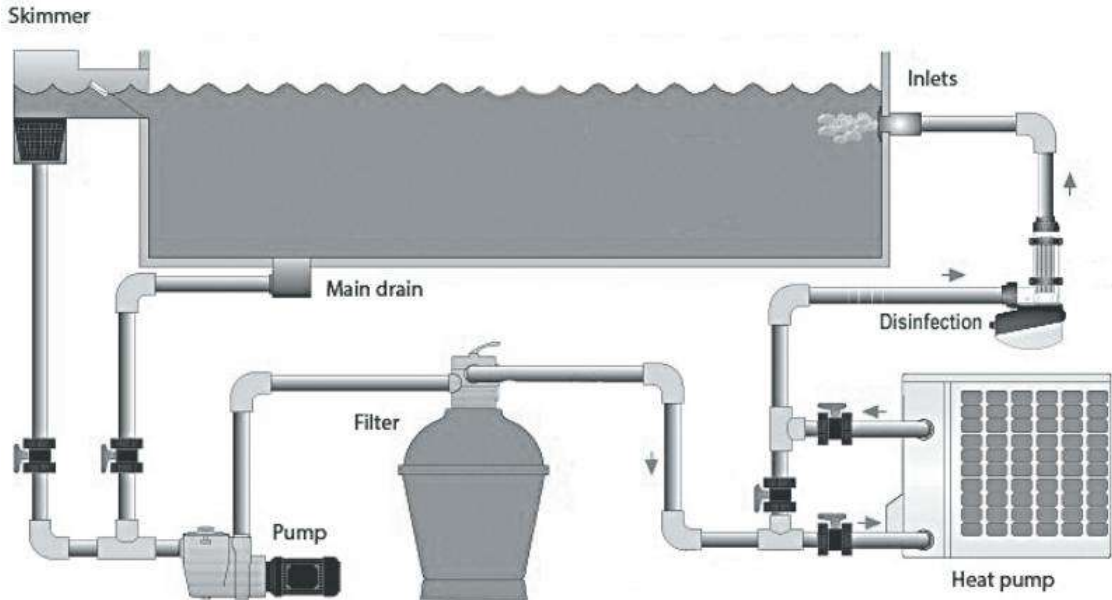

Above illustration is just for the reference, please take the advice of authorized installers.

## 3.2 Advised installation space

Keep the following indicated space for operation and maintenance when make the installation.

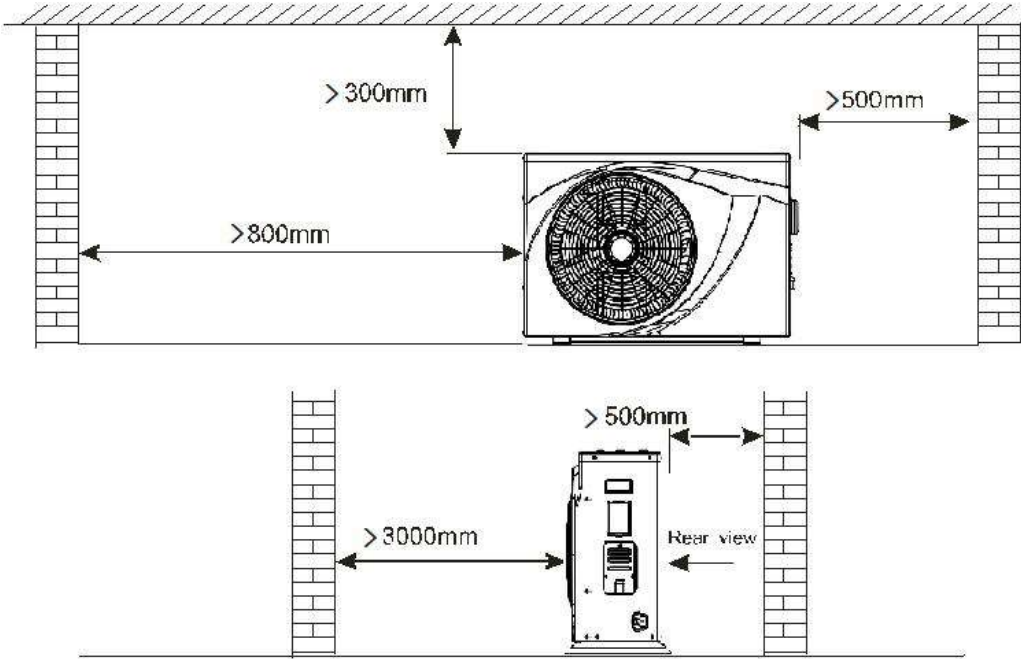

### 3.3 Additional By-pass kits

The additional By-pass kits is suggested to be put into the piping system to get the better adjustment of water flow.



### 3.4 Heat pump unit size

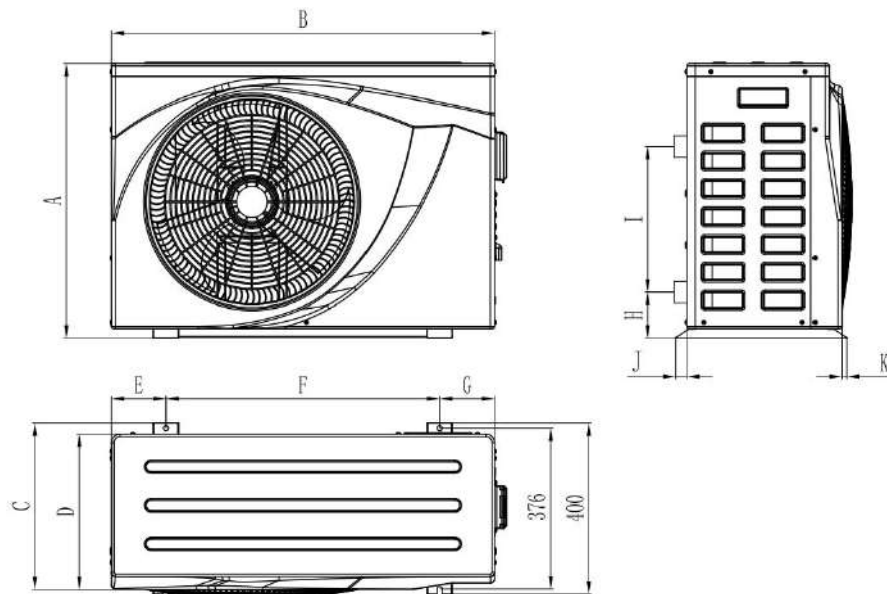

	A	B	C	D	E	F	G	H	I	J	K
WFI-007/010	591	836	379	335	98	640	98	107	290	26	11
WFI-013/017/021	641	896	389	363	128	640	128	107	340	26	11



### 3.5 Heat pump Exploded View

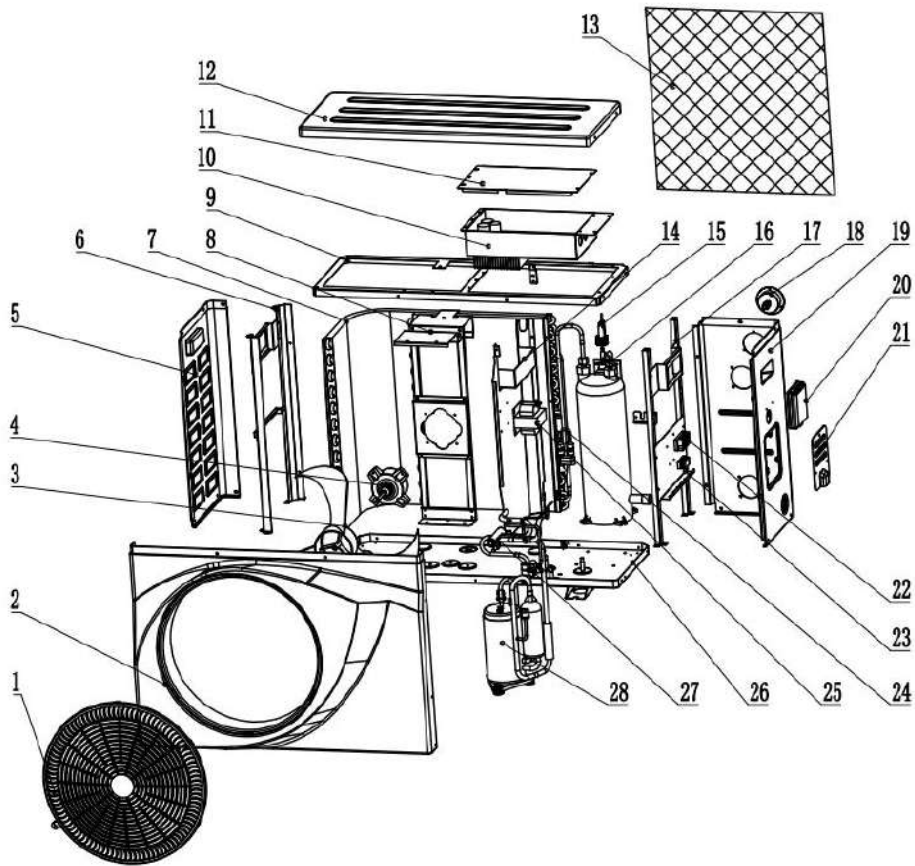

No.	Parts	No.	Parts
1	Fan protective gill	15	Water flow switch
2	Front panel	16	Titanium heat exchanger
3	Fan blade	17	Right structure
4	Fan motor	18	Manometer
5	Left panel	19	Right panel
6	Left structure	20	Control panel
7	Evaporator	21	Electrical terminal cover
8	Fan motor mount	22	Electrical terminal block
9	Upper structure	23	Electrical cable support
10	Electric box cover	24	Electronic expansion valve
11	Electrical box	25	Reactive resistance
12	Top cover	26	Bottom panel
13	Plastic net	27	Four-way valve
14	Middle panel	28	Compressor

### 3.6 Electrical connection

\* Suggested power cable specification

Model	Power Cable Specification
WFI-007/010	3*1.5 mm <sup>2</sup>
WFI-013/017	3*2.5 mm <sup>2</sup>
WFI-021	3*4 mm <sup>2</sup>
Terminal	Terminal cable max. 4 mm <sup>2</sup>

\* Electrical connection

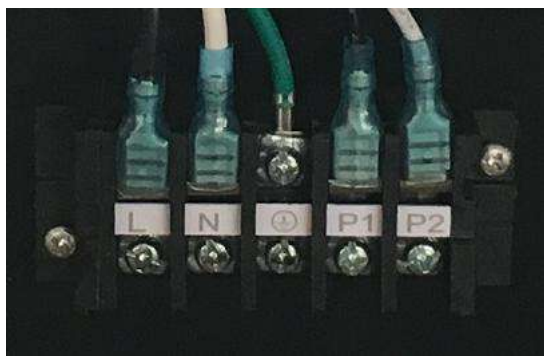

Position L,N and ⊕ is for the power connection of our heat pump.

Position P1 and P2 is for the Single phase water pump.

## 4. Specifications

### 4.1 Specifications

Model No.	WFI-007	WFI-010	WFI-013	WFI-017	WFI-021
<b>* Heating Capacity at Air 26°C, Humidity 80%, Water 26°C</b>					
Heating Capacity (kW)	7.6~1.7	10.5~2.3	13.5~3.0	17~3.8	21.1~4.8
Power Input (kW)	1.12~0.11	1.54~0.15	1.99~0.19	2.50~0.24	3.10~0.30
COP	15.8~6.8	15.8~6.8	16~6.8	15.8~6.8	15.8~6.8
<b>* Heating Capacity at Air 15°C, Humidity 70%, Water 26°C</b>					
Heating Capacity (kW)	5.8~1.3	7.8~1.7	10~2.2	12.7~2.8	15.8~3.5
Power Input (kW)	1.18~0.17	1.59~0.22	2.0~0.29	2.59~0.37	3.22~0.46
COP	7.6~4.9	7.6~4.9	7.6~5	7.6~4.9	7.6~4.9
<b>* Cooling Capacity at Air 35°C, Water 29°C in, 27°C out</b>					
Cooling Capacity (kW)	4.3~1.0	5.9~1.4	7.2~1.8	9.4~2.3	11.4~2.8
Power Input (kW)	1.13~0.15	1.55~0.21	1.89~0.27	2.47~0.34	3.0~0.42
EER	6.6~3.8	6.7~3.8	6.7~3.8	6.7~3.8	6.7~3.8
<b>* General data</b>					
Power supply	220~240V/1/50~60Hz				
Rated Power Input (kW)	1.18	1.59	2.0	2.59	3.22
Rated Current (A)	5.36	7.23	9.09	11.77	14.64
Water Flow Volume (m3/h)	2.5	3.5	4.5	5.5	6.5
Advised pool size m3	10~25	15~50	18~62	25~85	55~120
Compressor/ Type	Mitsubishi/ Rotary				
Refrigerant	R32				
Heat Exchanger	Screwed titanium tube				
Water connection (mm)	50				
Fan motor	Brushless DC type				
Defrosting function	Automatic/ Manual				
Water temp. range under heating (°C)	8~40				
Water temp. range under cooling (°C)	8~28				
Working temp. range (°C)	-15~43				
Casing Material	ABS				
Water Proof Level	IPX4				
Noise level dB(A) 10m	20~28	20~29	22~31	22~34	22~35
Noise level dB(A) 1m	38~48	39~49	42~51	43~54	43~55
Net Weight (kg)	42	43	53	54	58
Gross Weight (kg)	53	54	64	65	69
Net Dimensions (mm)	836*379*591		896*389*641		
Package Dimensions (mm)	930*400*650		990*435*750		

\* Above data are subjects to modification without notice.

## 5. Electrical wiring

### 5.1 Electric wiring diagram

WFI-007/010

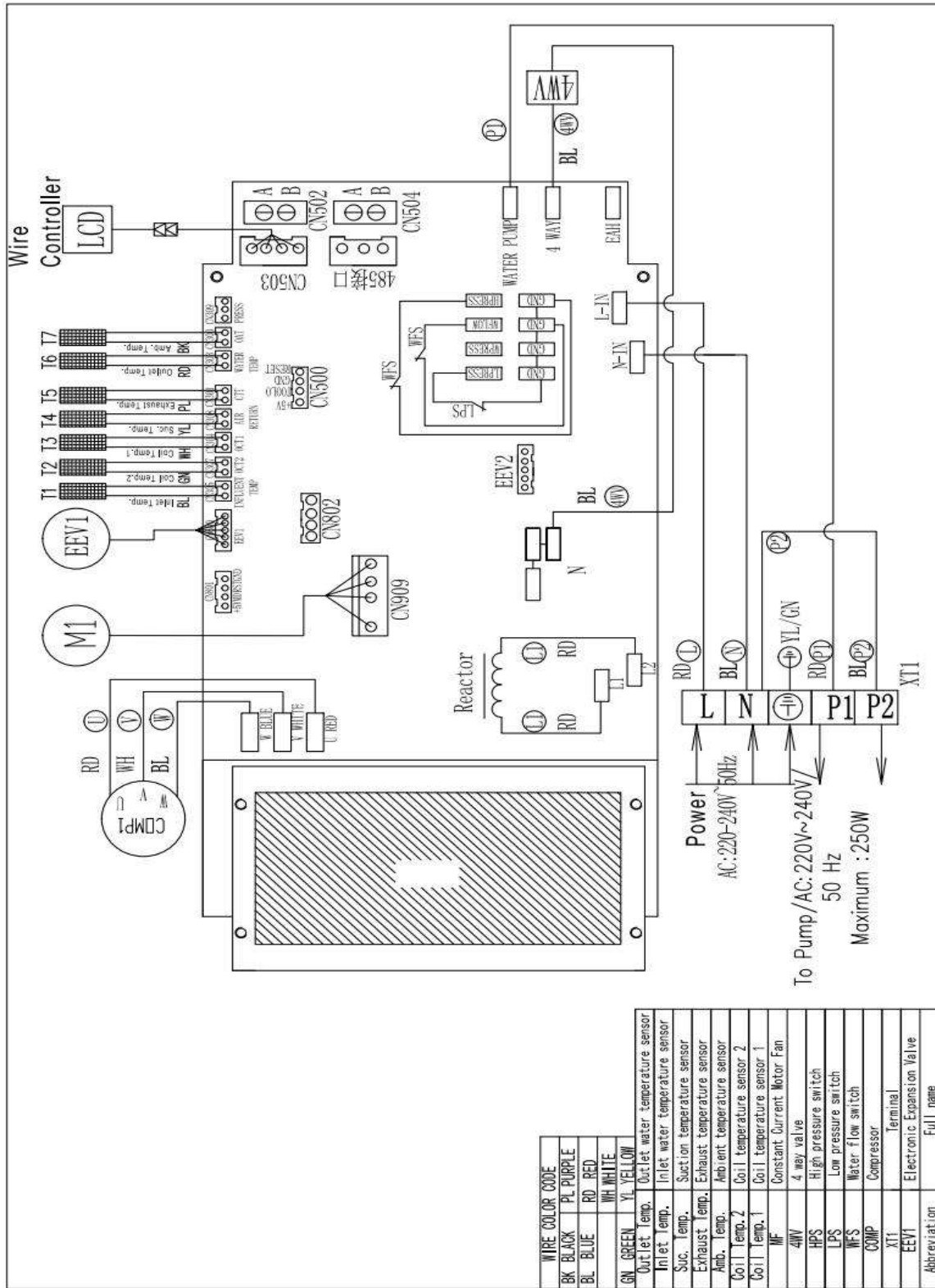

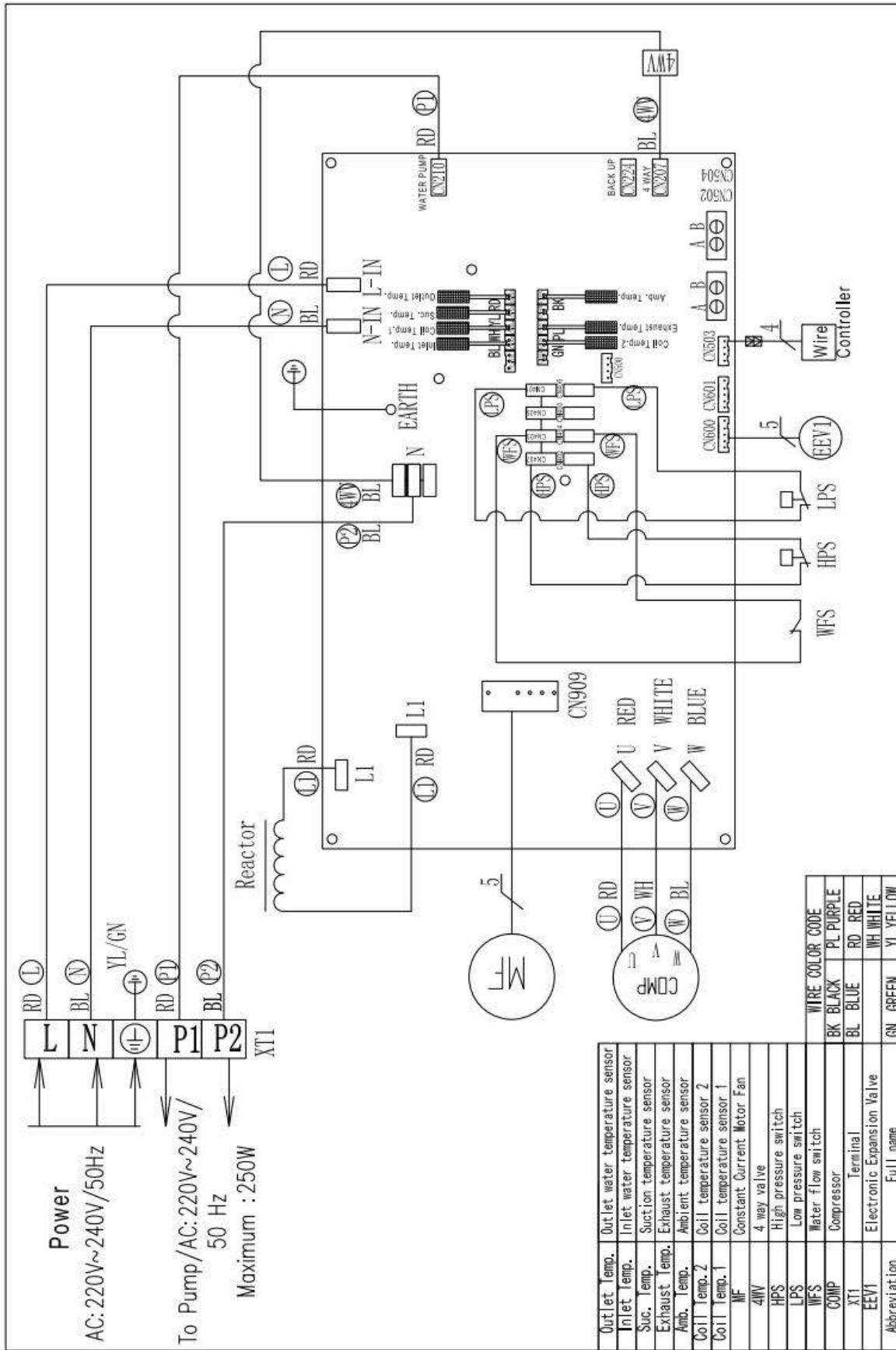

## 6. Instruction of operation

### 6.1 Wire controller (Function of buttons)

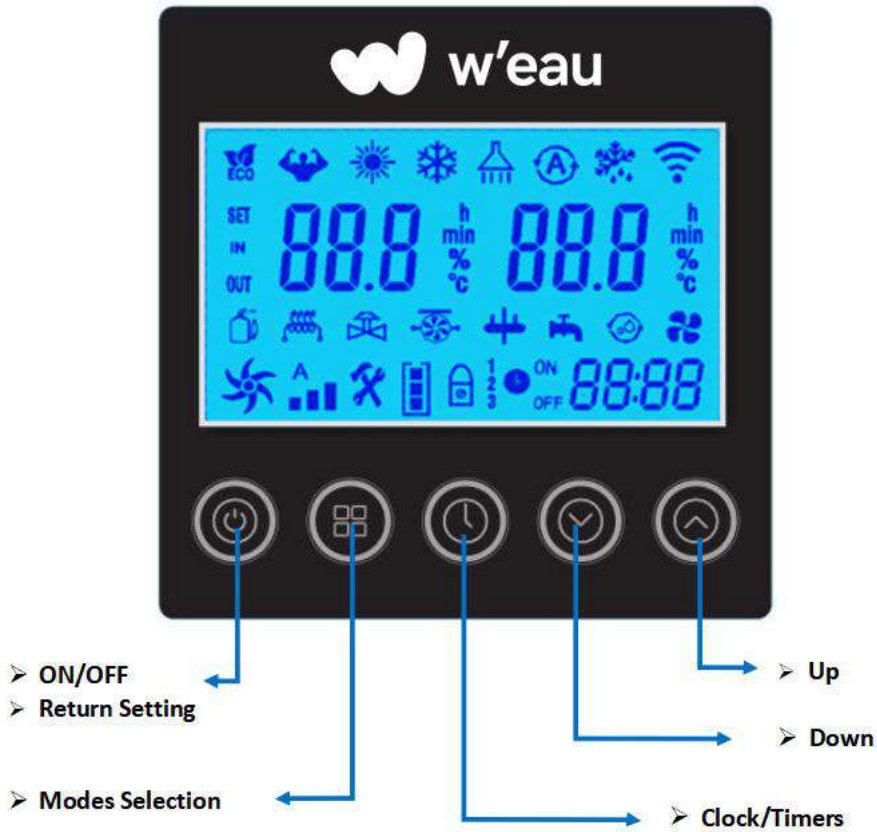

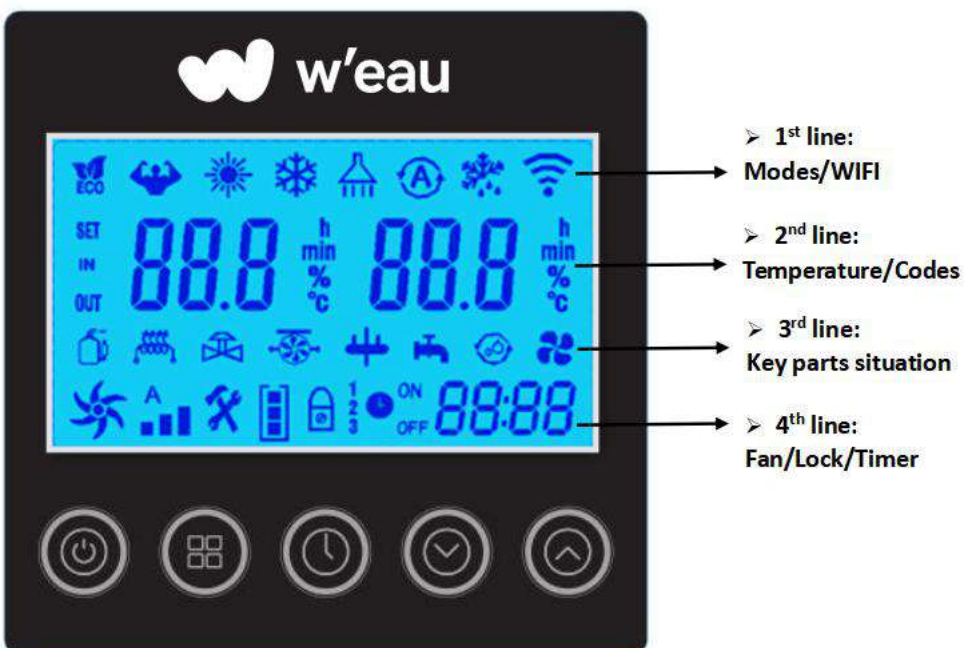

### 6.2 Definition of display



### 6.3 Start up & Locking



Press the button  to switch the heat pump on or off. This button is also used to return to the main interface.

When the heat pump is in operation, hold the button  for 3 seconds to lock or unlock the controller. (The lock is activated automatically after 60 seconds of inactivity). When the display is locked, the logo  appears.



**\* Please unlock the controller before the other operations every time.**



 **Attention: Before you start, make sure the filtration pump is running and that water is flowing through the heat pump.**

### 6.4 Operation Mode Selected



Hold the button  for 3 seconds to change the below four operating modes each time:

  : **Mode ECO Inverter:** Choose this heating mode that the heat pump operates silently.



  : **Mode Boost Inverter:** Choose this heating mode that the heat pump operates powerfully.

 : **Mode Cooling Inverter:** Choose this cooling mode that the heat pump intelligently cools the water of your pool.

 : **Mode Auto:** The heat pump can switch Heating and Cooling function automatically

### 6.5 Set the required temp.



On the main interface, press  and  to adjust the desired water temp. of your pool, then press the  to save the setting.

When setting the water temp., the icon 'SET' will light on, the left one is Setting temp., the right one is the Outlet water temp.





After finished the setting, the icon 'SET' will extinguish, the left one will become Inlet water temp., the right one Outlet water temp.



## 6.6 Clock setting



Press the button  to enter the clock setting interface. Clock display on right bottom flashes.

Change the hours using  and , then press again  to go to minute setting, change the minutes using the  and .

Press again  to confirm the setting and return to the main menu.

## 6.7 Timer setting

Hold the button  for 3 seconds to enter the setting of Timer ON & Timer Off groups.



 will flash, then set the Turn On and Off timer like the Clock setting.

**Pay attention: There are 3 groups Timer for your every day setting.**

You can press  to save the current setting and go back to the main interface.

**Cancel the Timer:** Hold the button  for 3 seconds to cancel all the timer setting.

## 6.8 Definition of other icons





: Defrosting



: Compressor





: 4-way valve

 Fan Speed    
  : Signal of Water pump    
  : Wi-Fi function

 **Attention:** With the indication of the functions or key parts, it is helpful for service team to maintain or repair the heat pump.

### 6.9 Manual defrosting



Hold  and  for 3 seconds to start Manual defrosting function.

### 6.10 Factory setting recovery

Hold  and  and  and  for 5 seconds to recover factory setting.

### 6.11 Running Parameter checking



Press  to enter the Running parameters checking, then press  and  to check the below parameters as below:

N°	Description	Unit
C01	Ambient temperature	°C
C02	Evaporator coil temperature	°C
C03	Exhaust temperature	°C
C04	Return temperature	°C
C05	Reserved	°C

C06	Reserved	°C
C07	Titanium heat exchanger temperature	°C
C08	Water inlet temperature	°C
C09	Water outlet temperature	°C
C10	Reserved	
C11	Reserved	
C12	Reserved	
C13	Temperature sensor failure	
C14	Refrigerant system failure	
C15	Inverter driver failure	
C16	Device output	
C17	Running status	
C18	AC voltage	V
C19	DC voltage	V
C20	Actual frequency	Hz
C21	EEV open degree	
C22	Reserved	
C23	Heat pump current	A
C24	Compressor current	A
C25	DC fan motor1 speed	Rpm
C26	Compressor target frequency	Hz
C27	DC fan motor2 speed	Rpm
C28	Control system software version	
C29	Driver software version	
C30	Controller software version	

## 7.Adjusting and Initial operation

### 7.1 Attention

- Open the valve of water system, inject water into the system, and exhaust air inside.
- Do adjustment after electrical safety inspection.
- After the power is switched on, start the test running of heat pump, to check if it can function well.
- To avoid dangerous accident, the forced operation is forbidden.

### 7.2 Preparation Before Adjustment

- The system is installed correctly.
- Tubes and lines are putted in the right place.
- Accessories are installed.
- Ensure the smooth drainage.
- Ensure the perfect insulation.
- Correct connection of ground lead.
- The supply voltage can meet the requirement of rated voltage.
- Air inlet and outlet function can work well.
- Electrical leakage protector can work well.

### 7.3 Adjustment Process

- Check if the switch of the controller can work well.
- Check if the function keys of the controller can work well.
- Check if the drainage system can work well.
- Check if the system can work well after starting up.
- Check if the water outlet temperature is in correct situation.
- Check if there is vibration or abnormal sound when the system is functioning.
- Check if the wind, noise and condensate water produced by the system affect the environment around.
- Check if there is refrigerant leakage.
- If any Error codes occur, please check the instructions for the detailed info.

## 8. Operation and maintenance

**8.1 To ensure the well functioning, the system should be checked and maintained after a period of time. During the maintenance, please pay attention to some points below:**

- When you need open the cabinet and make inside inspection, please do cut off the electricity power in advance.
- To ensure the stable running, please do not adjust any setting.
- Pay close attention to whether all the operation parameters is normal during system working.
- Examine regularly whether the electrical connection is loose, if yes, fasten it on time.
- Examine regularly the reliability of the electrical components, change all the failed or unreliable components on time.
- The dirt retention on the surface of evaporator fin should be cleaned every 6 months.
- After long downtime, if we restart the equipment, we should make following preparations: examine and clean the equipment carefully, clean the water pipeline system, examine the water pump, and fasten all the wire connections.
- Replacement parts must use the original accessories, can not be replaced by other similar accessories.

### 8.2 Refrigerant filling

Examine the refrigerant filling condition through reading the data of gauge, also the air suction and exhaust pressure. If there is leakage or changing components of the refrigeration circulation system, please ask for the assistant of professional technicians.

### 8.3 Leak detection

During leak detection and air tightness experiment, never let the refrigeration system filling oxygen, ethane or other flammable harmful gas, we can only adopt compressed air, fluoride or refrigerant for such experiment.

### 8.4 Drainage water in heat exchanger

If the heat pump will be not used for a long time or in winter season, please do drain the water inside heat exchanger to avoid broken when freezing.

### 8.5 To remove the compressor, please follow the following steps

- Turn off the power supply
- Exhaust the refrigerant from the low pressure end, attention to reduce the exhaust speed, and avoid frozen oil leakage.
- Remove the compressor air suction and exhausting pipe.

- Remove the compressor power cables.
- Remove the compressor fixing screws.
- Remove the compressor.

**8.6 Conduct regular maintenance according to the user manual instruction, to make sure the unit running in good condition.**

- Fire prevention: if there is a fire, please turn off the power switch immediately, put the fire out with fire extinguisher.
- To prevent flammable gas: the unit working environment should stay away from gasoline, ethyl alcohol and other flammable materials, to avoid explosion accident.

## 9. Error codes & Solutions

Code	Description	Potential reasons	Solutions
E03	Water flow protection	Insufficient water flow	Check the water circuit system, the opening of by-pass kits, the running of water pump
		Water flow switch disconnected	Check the wiring and reconnect water flow switch
		Water flow switch defective	Change a new one
E04	Antifreeze protection	Ambient/Inlet water temp. is too low and the unit is on standby	The unit will be re-started when the ambient/inlet water temp. goes up.
E05	High pressure protection	Insufficient water flow	Check the water circuit system, the opening of by-pass kits, the running of water pump
		Ambient/ Water temp. is too high	
		Fan motor speed is abnormal or fan motor has damaged	Check the fan motor
		Excess refrigerant gas	Readjust the refrigerant volume
		High pressure switch disconnected or defective	Reconnect or replace high pressure switch
		Piping system jammed	Check the piping system
E06	Low pressure protection	Bad ventilation	Check the installation circumstance. Clean the evaporator. Check the running situation of fan.
		Low pressure switch disconnected or defective	Reconnect or replace low pressure switch
		Gas leakage (Check the gauge)	Detect the leakage point and make the maintenance
		Fan motor speed is abnormal or fan motor has damaged	Check the fan motor
		EEV blocked or piping system jammed	Check the piping system
E09	Connection failure between PCB and controller	Bad wire connection	Check the wiring
		Defective controller	Change a new controller
		Defective PCB	Change a new PCB
E10	Communication failure between PCB and driver module	Bad wire connection	Check the wiring
		Defective PCB	Change a new PCB
E12	Exhaust temp. too high	Insufficient water flow	Check the water circuit system/ water flow switch
		Lack of gas	Check if there is a gas leakage
		Piping system jammed	Check the piping system
		Exhaust piping temp. sensor (Purple connector) defective	Change a new sensor
E15	Inlet water temp. sensor (Blue)	Sensor disconnected or defective	Reconnect or replace sensor

	connector) failure		
<b>E16</b>	Outer piping temp. sensor (White connector) failure	Sensor disconnected or defective	Reconnect or replace sensor
<b>E18</b>	Exhaust piping temp. sensor (Purple connector) failure	Sensor disconnected or defective	Reconnect or replace sensor
<b>E21</b>	Ambient temp. sensor (Black connector) failure	Sensor disconnected or defective	Reconnect or replace sensor
<b>E22</b>	Difference of outlet and inlet water temp. too high	Insufficient water flow	Check the water circuit system/ water flow switch
		Outlet water temp. sensor (Red connector) failure	Change a new sensor
		Inlet water temp. sensor (Blue connector) failure	Change a new sensor
<b>E23</b>	Overcooling protection under cooling mode	Insufficient water flow	Check the water circuit system/ water flow switch
		Outlet water temp. sensor (Red connector) failure	Change a new sensor
<b>E27</b>	Outlet water temp. sensor (Red connector) failure	Sensor disconnected or defective	Reconnect or replace sensor
<b>E29</b>	Suction piping temp. sensor (Yellow connector) failure	Sensor disconnected or defective	Reconnect or replace sensor
<b>E30</b>	Low ambient temp. protection	Beyond the scope of using temp.	Stop using
		Ambient temp. sensor (Black connector) failure	Change a new sensor
<b>E32</b>	Overheating protection under heating mode	Insufficient water flow	Check the water circuit system/ water flow switch
		Outlet water temp. sensor (Red connector) failure	Change a new sensor
<b>E33</b>	Piping temp. too high protection under cooling mode	Ambient/water temp. is too high under cooling mode	Check the scope of using
		Refrigerant system is abnormal	Check the piping system
<b>E34</b>	Compressor start up failure	Bad wire connection for compressor	Check the wiring
		Wrong phase connection for compressor	Check the wiring
		PCB failure	Change a new one
<b>E35</b>	Compressor over current	Power supply is abnormal	Check the power supply
<b>E36</b>	Compressor output failure	Wrong phase connection for compressor	Check the wiring
<b>E42</b>	Inner piping temp. sensor (Green connector) failure	Sensor disconnected or defective	Reconnect or replace sensor
<b>E46</b>	DC fan motor malfunction	Bad wire connection	Check the wiring of fan motor
		Fan motor defective	Change a new fan motor



# 10. Wifi-Function

1. Download the 'Tuya Smart' App



Scan the QR code below to download the mobile APP.



Or search 'Tuya Smart' in App Store (IOS) or Google play (Android)

2. Sign up for the first time

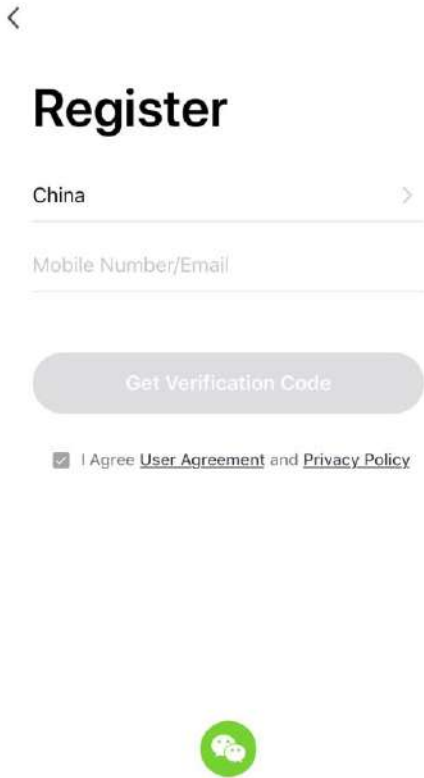

3. Press '+' to add a device
4. Choose 'Others' and 'Other Wifi' on the interface

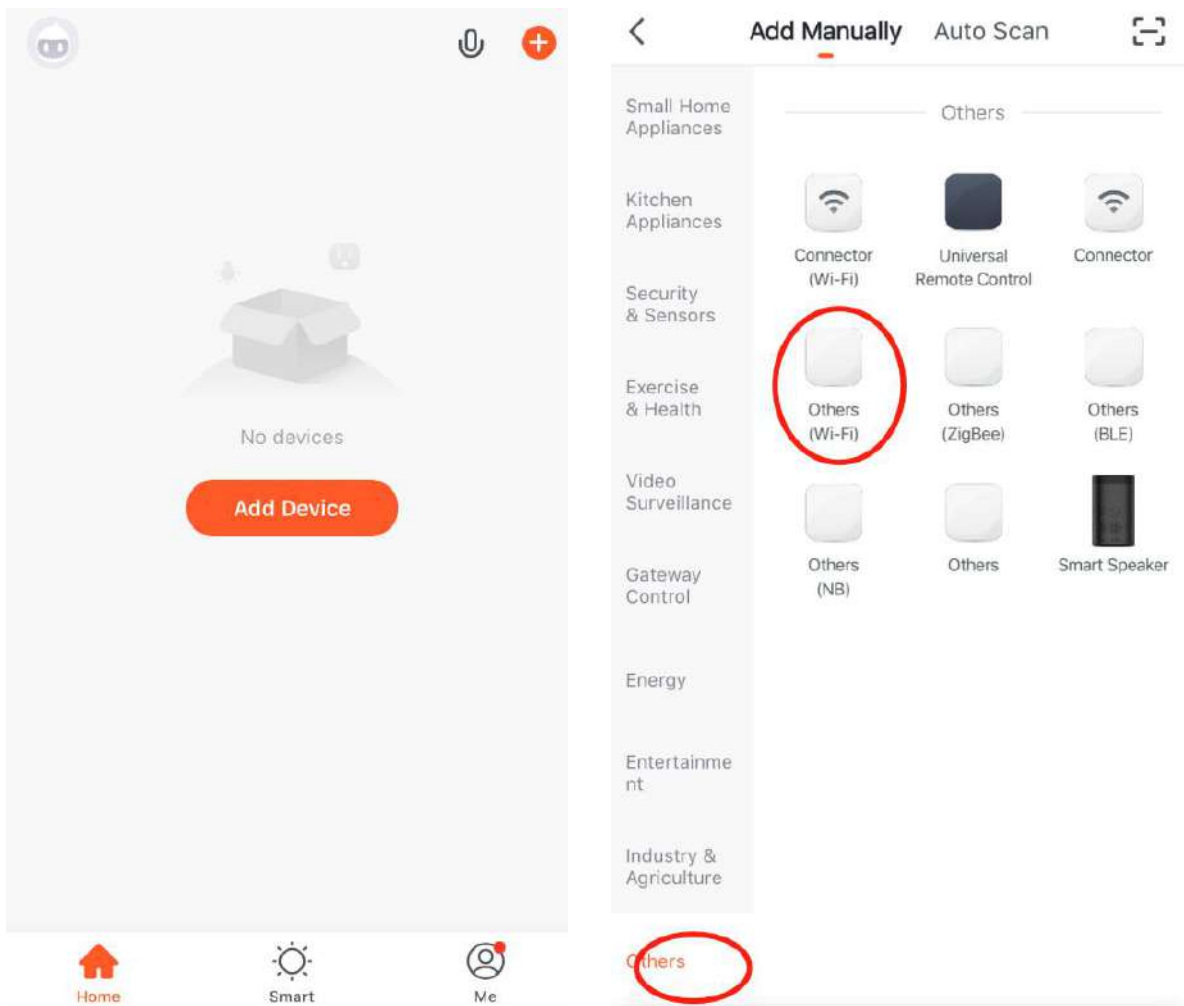

5. Put your mobile phone close to the pool heat pump, which are under the same Wifi area

6. Make sure the device is reset, then enter the WIFI account and password to connect Wifi.

Reset the Wifi function: Hold the  and  and  for 3 seconds.

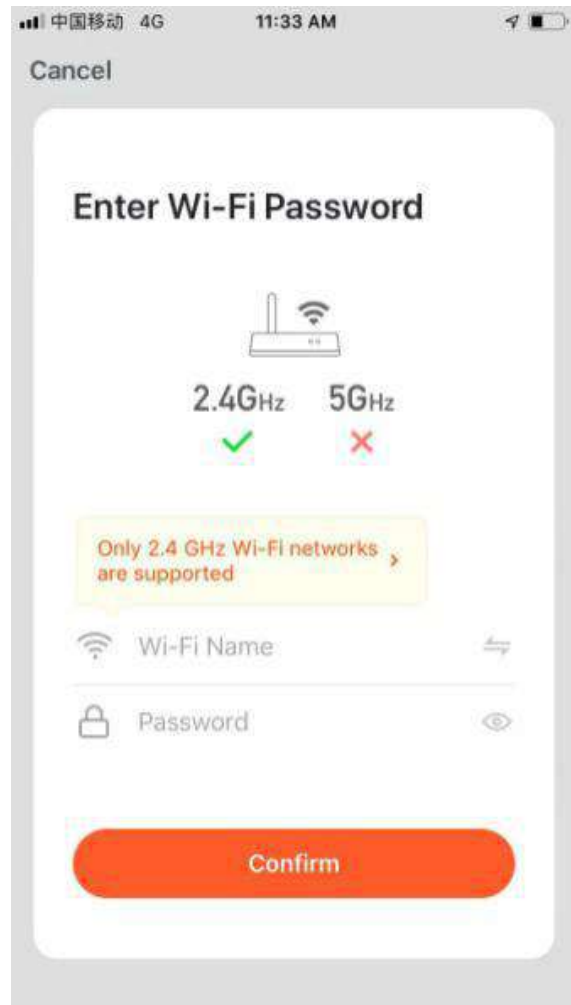
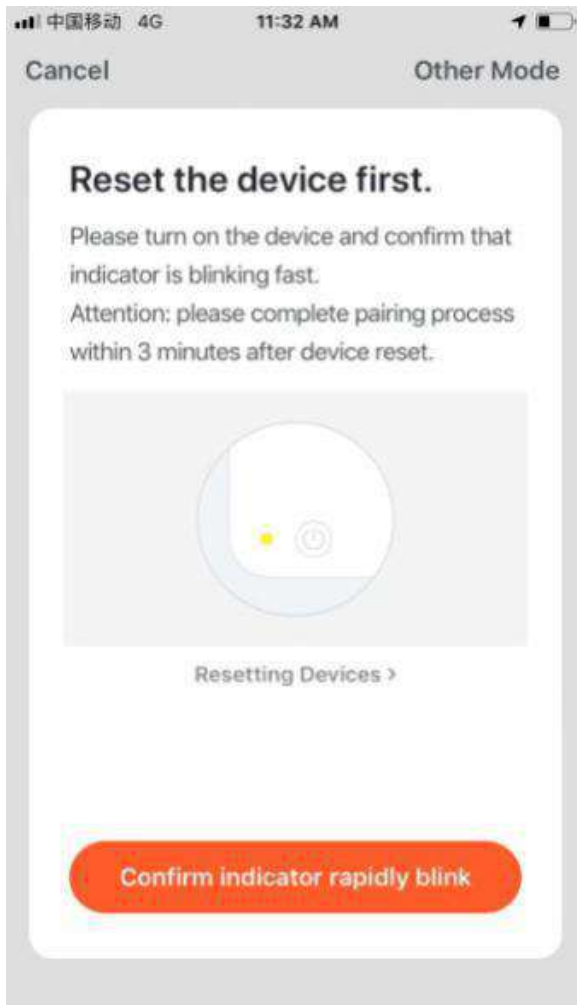

7. Press 'Confirm' to start the connection after completing. The device is successfully added if it's connect, then press 'Finish'.

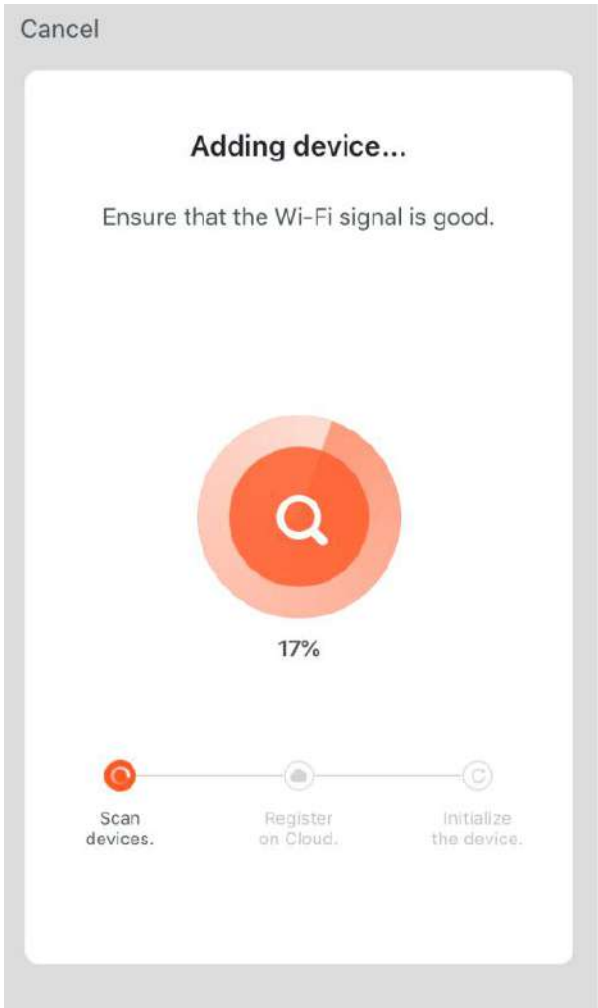
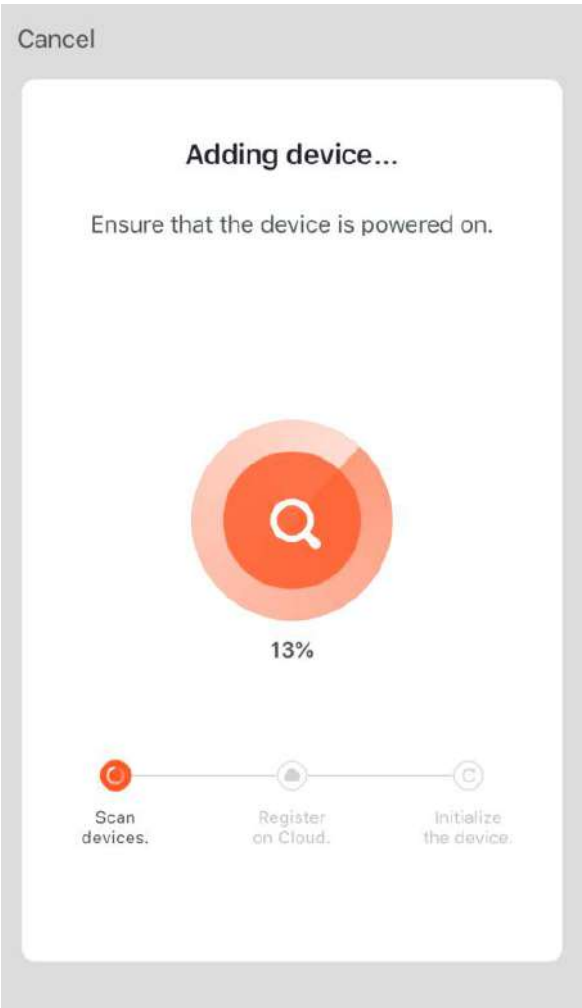

## 8. App Main Interface



## 9. Functions

Remark: The heat pump APP function includes:

- Turn On/Off the machine
- Temperature setting and display
- Mode Selection
- Failure status display





