

CARSON[®]

MM-450

POCKETMICRO[™]

20x - 60x ZOOM POCKET MICROSCOPE

INSTRUCTIONS FOR USE



www.carson.com/MM450guide
English / Français / Español / Deutsch / 日本語



Product Overview

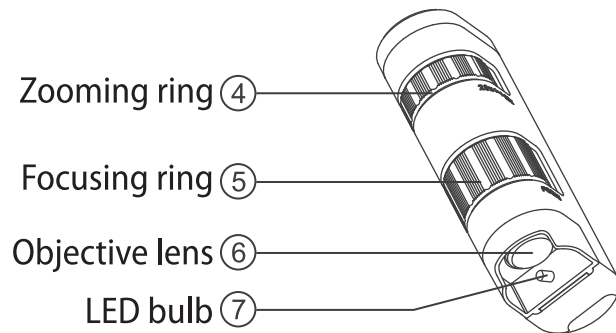
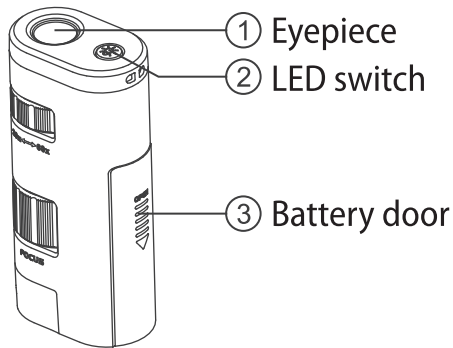

Installing the Battery

1. Slide open the battery door ③ as shown below.

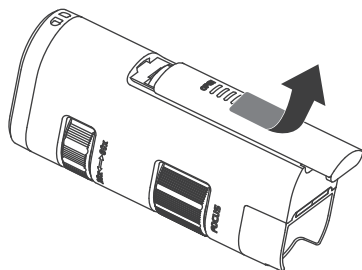

2. Install 1 AA battery with the polarity shown below.

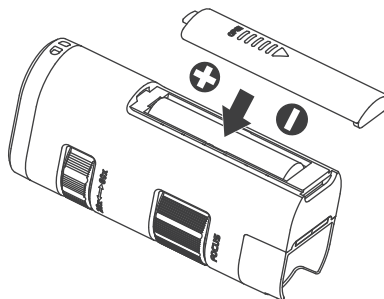

3. Reattach battery door ③ as shown below.

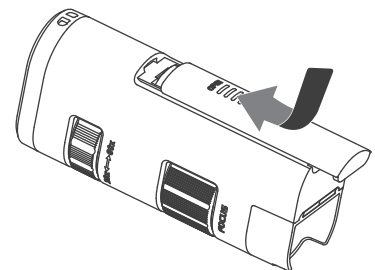

Using the Microscope

Place the viewing subject directly below the objective lens ⑥.

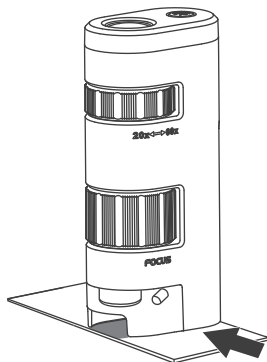

Press the LED button ② to turn on the LED.

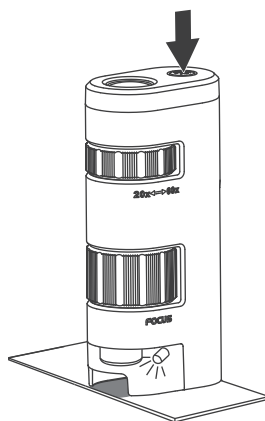

Adjust the zooming ring ④ to the desired level of magnification.

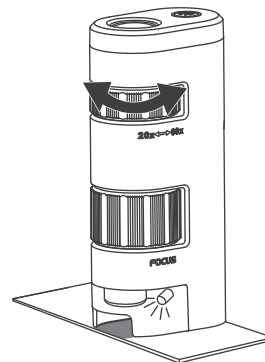

Rotate the focusing ring ⑤ until the image is sharp and clear.

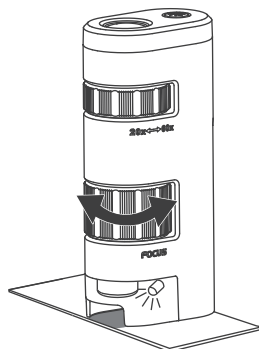

Turn off the LED when finished by pressing the LED button ②.

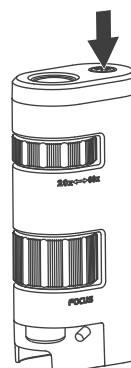

Specifications

Magnification: 20 - 60x

Eye Relief: 8.1mm - 9.7mm

Optical Zoom: 3x

Battery Type: 1 x AA battery (not included)

Illumination: LED

Dimensions: 3.9" x 1.8" x 1.1"

Weight: 1.9 oz. (excluding battery)

Safety Information

1. To avoid possible permanent eye damage, do not look at the sun or any bright objects with the microscope.
2. To avoid possible permanent eye damage, do not place the lighted microscope directly upon human eye.
3. Remove the battery before storing the microscope for an extended period.
4. Inspect all batteries for signs of corrosion or leakage. Do not expose to fire or excessive heat. Use alkaline batteries only, rechargeable batteries not recommended. Insert battery in the direction indicated.
5. Remove exhausted batteries from device.