

Robotic Pool Cleaner LIBERTY

LIBERTY™ 100 | 200 | 300 | 400

User Instructions



8159110



EN

LIBERTY 100 | 200 | 300 | 400 Cordless Robotic Pool Cleaner

User Instructions

Content

Safety Instructions

- 1. Getting Started..... 5
 - 1.1 What's in the Box 5
 - 1.2 First Time Use..... 5
- 2. Specifications..... 6
 - 2.1 Robot..... 6
 - 2.2 Water Conditions..... 6
 - 2.3 Battery Charger 6
- 3. Features and Indications 6
- 4. Charging Recommendations7
- 5. Removing the Robot from the Pool..... 7
 - 5.1 Using the Grab Hook..... 7
 - 5.2 Using the ClickUp™ Clicker (LIBERTY 300 + 400) 7
 - 5.3 End of Cycle Pickup (LIBERTY 300 + 400)..... 7
- 6. Cleaning the Filter Basket 8
- 7. Periodic Cleaning..... 9
 - 7.1 Cleaning the Impeller 10
- 8. MyDolphin™ Plus App User Guide (LIBERTY 400 Only)..... 11
 - 8.1 Getting Started with the MyDolphin™ Plus App..... 11
 - 8.2 Prepare the Pool Cleaner for Connection 11
- 9. Activate the Pool Cleaner Using your Mobile Phone (LIBERTY 400)..... 11
 - 9.1 MyDolphin™ Plus App Features Guide 11
- 10. MyDolphin™ Plus Troubleshooting 12
- 11. Robotic Pool Cleaner Troubleshooting 13
- 12. Off-Season Storage..... 13
- 13. Contact Maytronics Customer Care..... 14

READ AND FOLLOW ALL INSTRUCTIONS



Please adhere strictly to following **WARNINGS:**

1. Remove the robotic pool cleaner from the pool before allowing people to enter the pool.
2. When examining the robotic pool cleaner, make sure the robotic pool cleaner is switched OFF.
3. Charge the battery only in the temperature range between 6°C to 35°C / 43°F - 95°F.
4. Keep the robotic pool cleaner out of the reach of children or persons with reduced physical, sensory, or mental capabilities, or lack of experience and knowledge, unless they have been given supervision or instruction.
Cleaning and maintenance shall not be done by children.
5. Use only the original battery charger.
6. The battery charger must be supplied through a power circuit protected by a residual current device (RCD) having a rated residual operating current not exceeding 30mA.
7. The power cord is not user-replaceable. If the power cord is damaged, stop using the battery charger and contact the service center for repair. Do not use extension cord to connect the battery charger to electric supply; provide a properly located outlet.
8. DO NOT USE the robotic pool cleaner and/or its battery / power pack in case of mechanical damage to the robotic pool cleaner and/or its battery.
9. To avoid the risk of fire and burns, DO NOT open, crush, heat, or burn the battery case.



Please ensure that the following **PRECAUTIONS** are implemented:

1. For continuous protection against possible electric shock, place the battery charger at least 11 cm / 4 in above ground.
2. Position the battery charger at least 3.5 m / 12 ft from pool edge during operation.
3. When cleaning the impeller, use the impeller safety tool. See user manual.
4. Keep hands and fingers away from impeller motor area and driving belt mechanism to avoid injury.
5. When lifting the robotic pool cleaner, take care to prevent back injury.
6. Do not use the robotic pool cleaner if you have added liquid flocculant or any other clarifier to the pool water. These substances obstruct and damage the robot filters.

IMPORTANT SAFETY INSTRUCTIONS



The Lithium-Ion battery in this product is non-replaceable. It should be recycled at certified battery electronics recyclers that accept batteries. Batteries should NOT be discarded in the trash or put in municipal recycling bins. Do not disassemble the battery.



Impeller blades hazard



WARNING



Read User Instructions before servicing

This product complies with EU Directives 2014/35/EU, 2014/53/EU, 2014/30/EU, RoHS and REACH. For full information, please contact us at www.maytronics.com/contact-us-en and ask for the EU Declaration of Conformity.

SAVE THESE INSTRUCTIONS

LIBERTY 100 | 200 | 300 | 400 Cordless Robotic Pool Cleaner User Instructions

1. GETTING STARTED

1.1 What's in the Box



LIBERTY™	Filter panels	Filter basket	Grab hook	Charger	Impeller tool	Clicker	Accessories organizer
100	4 fine	✓	✓	✓	✓		
200	2 fine / 2 ultra fine	✓	✓	✓	✓		
300	2 fine / 2 ultra fine + 2 ultra fine	✓	✓	✓	✓	✓	
400	2 fine / 2 ultra fine + 2 ultra fine	✓	✓	✓	✓	✓	✓

1.2 First time use

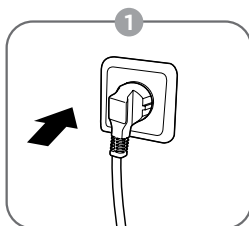

Plug the charger into the wall outlet

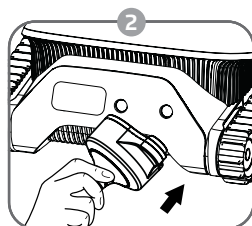

Connect the inductive charger to the robot



Peel-off the sticker

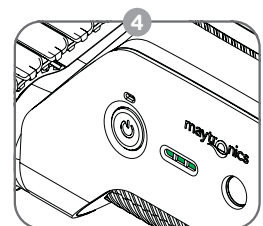

Charge the battery to 100% - 3 green bars

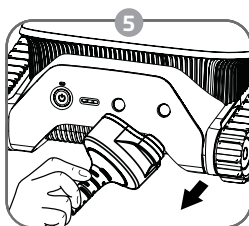

Unplug the inductive charger

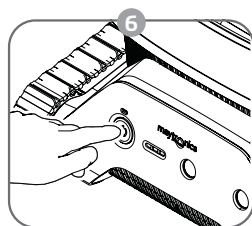

Press the power button

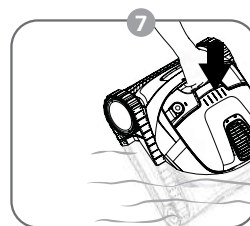

Put the robot in the pool. It will start cleaning within 30 seconds

2. SPECIFICATIONS

2.1 Robot

Water depth range: 0.3m - 3m / 1ft - 9.8ft
Motor protection: IP 68
Battery Lithium-ion | 5,000mAh | 25.2V ; 5Ah / 126Wh
Radio communication:
Bluetooth® 5.0 - 2402-2480 MHz - Maximum power 2.1mW

2.2 Water Conditions

Use the robotic pool cleaner only in the following water conditions:

- Chlorine: 4 ppm max.
- pH: 7.0 – 7.8
- Temperature: 6°C – 35°C / 43°F – 95°F
- NaCl: 5000 ppm max.

2.3 Battery Charger

- Protection: IP54 (Raintight)
- Output: <30 VDC

3. FEATURES AND INDICATIONS



Cycle Selector - LIBERTY 300 & 400

Use Cycle Selector to customize cleaning mode to "Floor only":

1. Press ON to activate until the LED lights up.
 2. Press ON again for 3-6 seconds until the purple LED blinks 3 times.
- Place the robot in the pool, and within 30 sec, it will start working.
After each cleaning cycle, the robot will return to default mode.



ClickUp™ - LIBERTY 300 & 400

Easily take the robot out of the pool by shaking the Clicker in the water for 3 seconds when the robot has finished the cleaning cycle. The robot will climb up its nearest wall and wait a few seconds to be picked up.



Eco Mode - LIBERTY 200, 300 & 400

Use Eco Mode to keep your pool floor clean for a week on one charge.

- The robot will automatically clean the pool floor for up to 40 min, three times a week.
LIBERTY 400 can also be set for 30 min four times per week or 60 minutes twice per week via the app.
1. Press ON to activate until LED lights up.
 2. Press again for 5-8 seconds until the LED flashes purple and then green.
 3. Place the robot in the pool, and within 30 sec, it will start working.

While in Eco Mode you can use the Clicker between cycles and at the end of the third cycle, however using the Clicker will cancel the eco mode.



Temperature Warning

In case of temperature warning notification, place and charge the pool cleaner in a protected and shaded area, at a temperature range of 6°C - 35°C / 43°F - 95°F.



Waterline Scrubbing - LIBERTY 200, 300 & 400

Scrubs then removes grime and oils that accumulate on the waterline.



MyDolphin™ Plus Mobile App - LIBERTY 400

Download the app, sign-up and follow the app instructions to pair with your robot. You can configure it with the MyDolphin™ Plus App while the robot is out of the water. When paired, the LED above the robot's power button will start flashing. Now you can schedule cleanups, set cleaning cycle type, and receive notifications when it is ready to be taken out of the pool.



Error

In case of error notification, please refer to User Manual.



4. CHARGING RECOMMENDATIONS

- When the battery is low and all indicators are off - the cleaner is on standby mode. Connect the charger to the robot to wake it up.
- Always charge the pool cleaner in a protected and shaded area at a temperature range of 6°C - 35°C / 43°F - 95°F, until you see 3 green bars in the battery indicator panel (up to 6 hours).
- Make sure that the charger surface and power unit surfaces are clean, and there is no object between the robot and the charger.
- The charger is rainproof, the robot can be charged when wet. However, do not put the charger in the water. It is not designed to be underwater.

5. REMOVING THE ROBOT FROM THE POOL

5.1 Grab hook

Pull robot to waterline, then grab it with your hand to pull it out of the water.



* Standard pole, not included

5.2 ClickUp™ - LIBERTY 300 & 400

After the cleaning cycle, shake the Clicker inside the water for over 3 seconds and the robot will climb its nearest wall. The robot needs to finish its cycle before it can be called up with the Clicker.

In regular mode, the feature will be available for 2 days after the cleaning cycle ends.

Please note: When in **Eco Mode**, you can use the Clicker between cycles and at the end of the third cycle, however using the Clicker will cancel the **Eco Mode**.



5.3 End of Cycle Pickup - LIBERTY 300 & 400

In the last few minutes of its cleaning cycle, it will climb each wall and wait 20 seconds to be taken out. If you started the cycle with the app, you will get a push notification on your phone to let you know the robot is waiting. If it isn't picked up, it will wait on the floor near a wall. You can then use the Clicker or hook to take it out.

6. CLEANING THE FILTER BASKET

To prevent debris from hardening on the filter, we highly recommend quick-rinsing the filter immediately after removing the robot from the pool.

Rinsing after each use - removing and cleaning the filter basket

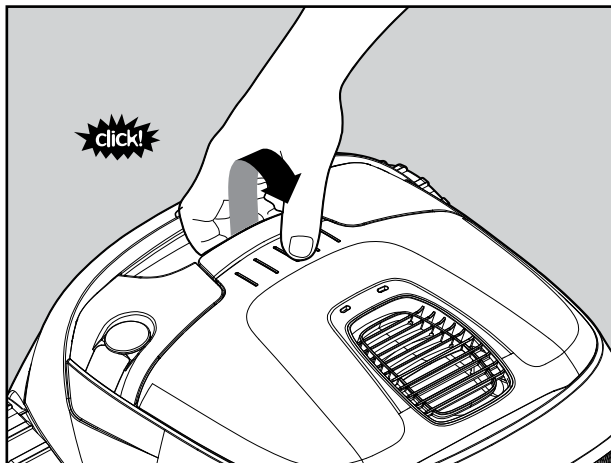

Open the filter cover.

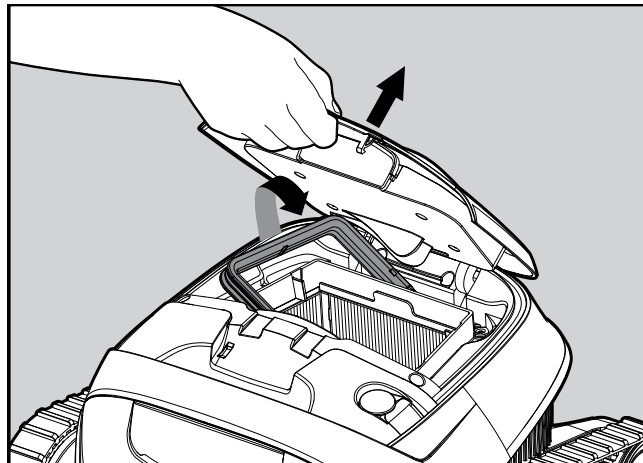

Upon opening the filter cover, the handle will lift independently.

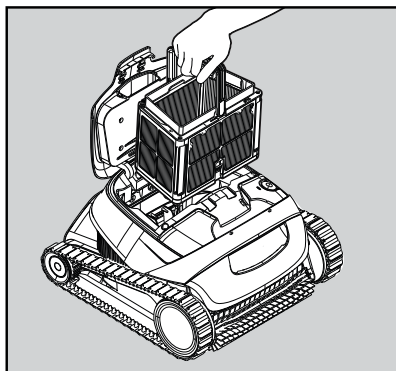

Lift up the basket.

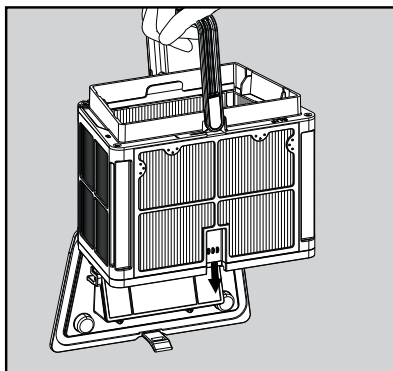

Open the latch to release the bottom lid in order to remove the debris.

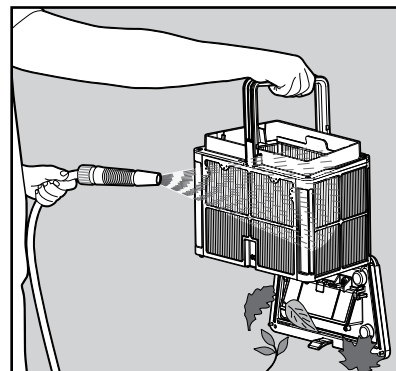

Rinse the filters from inside and outside with a hose.

7. PERIODIC CLEANING - RECOMMENDED ABOUT ONCE A MONTH

Dismantle the 2 ultra-fine filter panels of the basket, using the following steps:

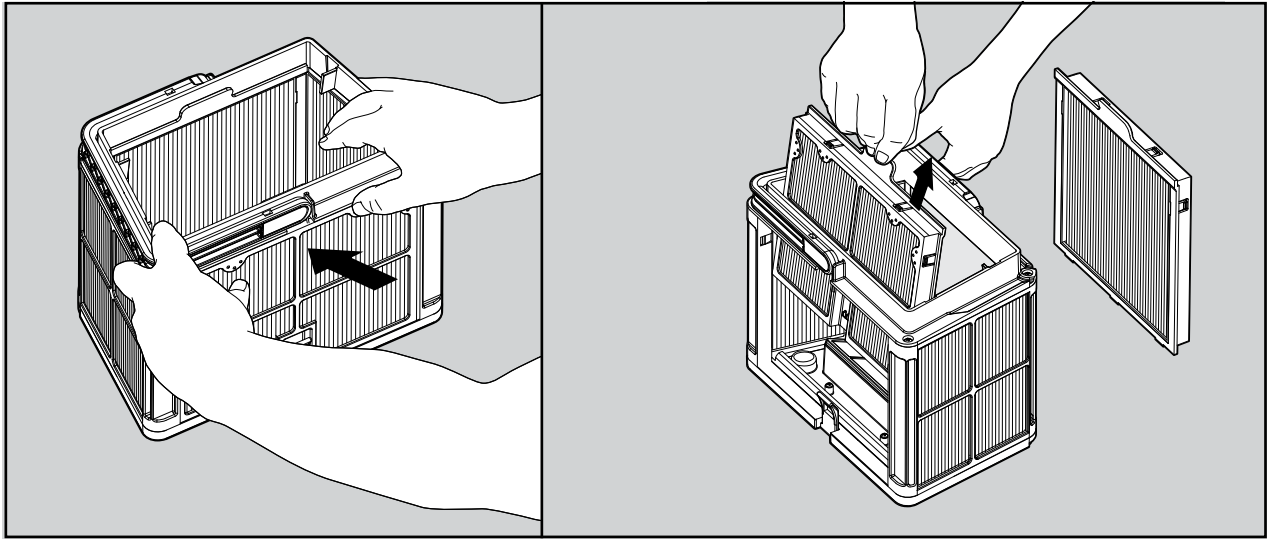

Dismantle the 2 panels with your thumbs.

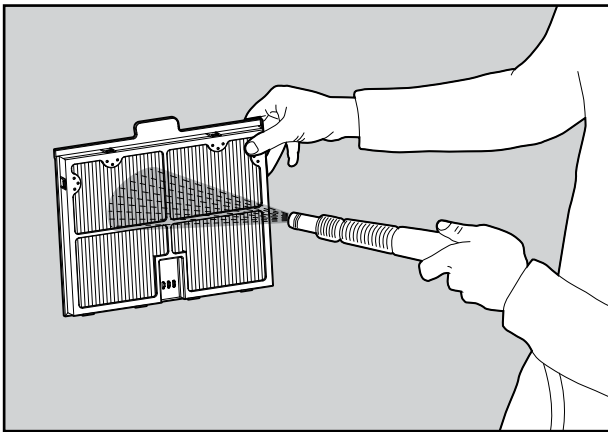

Clean the filter panels with a hose.

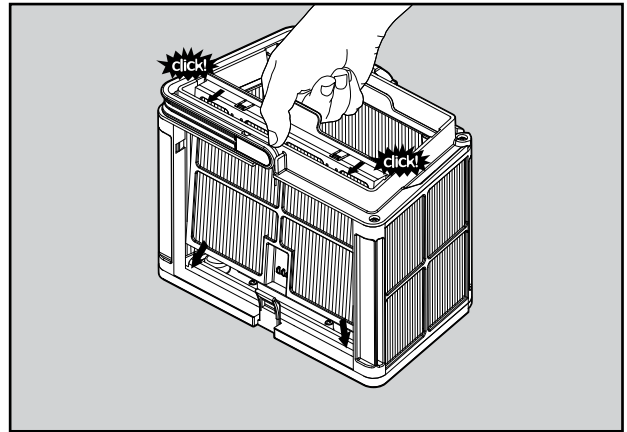

Re-assemble the filter panels.

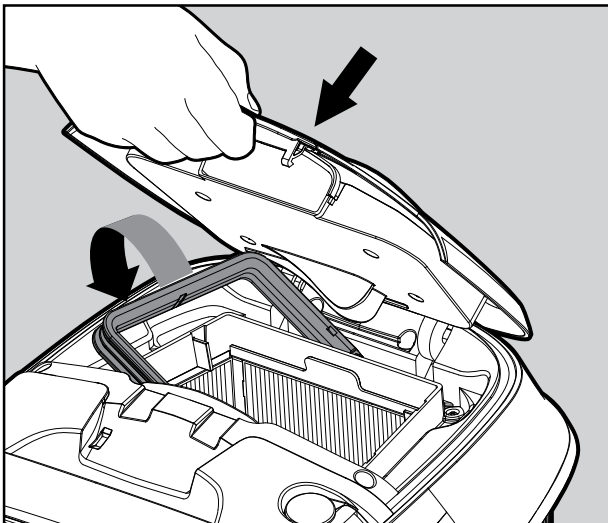

Insert the clean filter basket and close the filter cover.

7.1 Cleaning the Impeller

Hair and other debris can get stuck in the impeller causing the robot not to work well. Clean the impeller periodically to improve the robot's performance.

CAUTION: Make sure you connect the charger to turn the robot off and insert the impeller cleaning safety tool.



[Tap or scan for tutorial video](#)

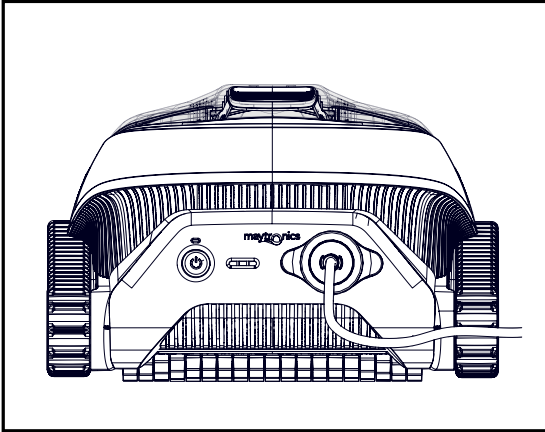

1. Connect the charger to the robot.

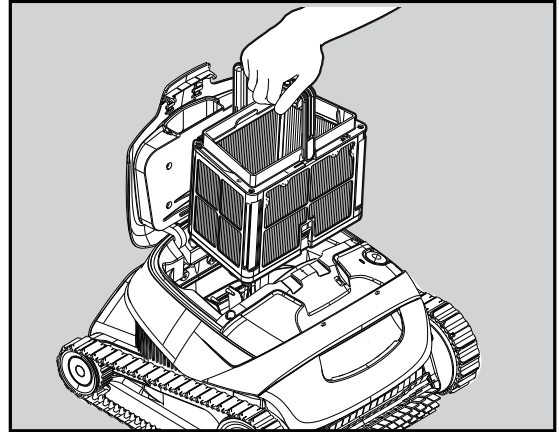

2. Open the lid and remove the filter basket.

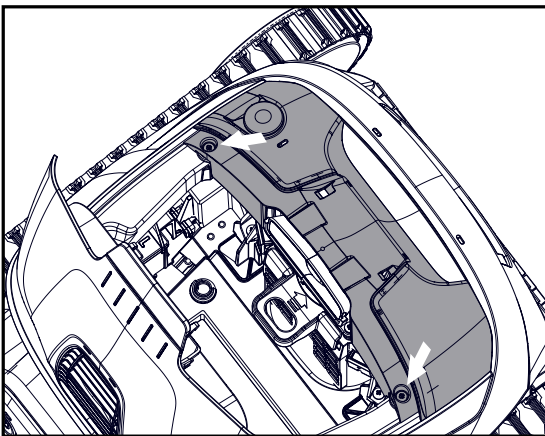

3. Remove 2 screws and remove the cover.

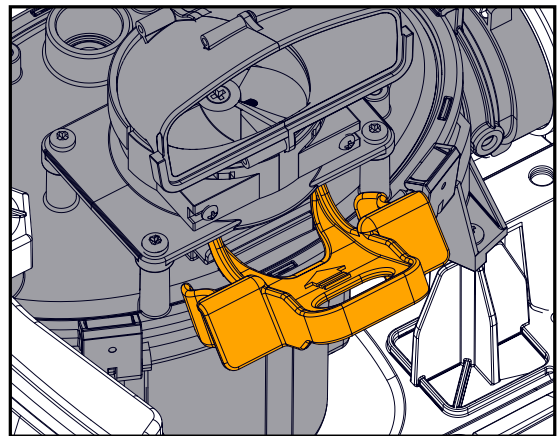

4. Insert the impeller safety tool.

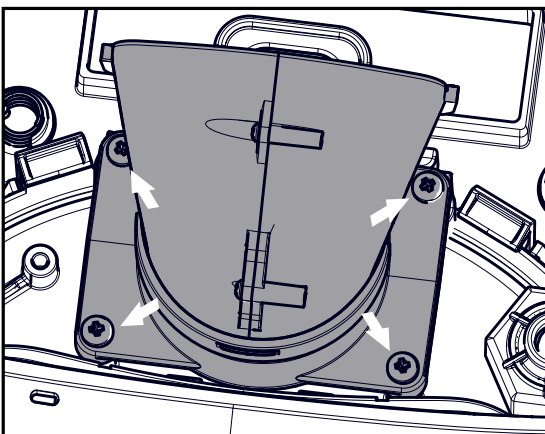

5. Remove 4 screws and remove the exhaust manifold

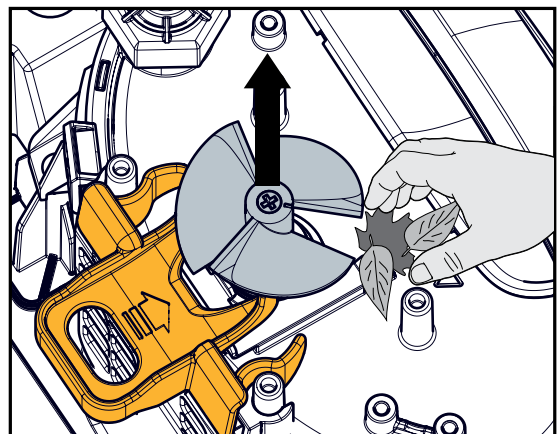

6. If needed, remove the impeller screw and carefully but assertively lift the impeller out to clean the debris.

7. Gently return the impeller, exhaust manifold, and cover.
8. Remove the safety tool.
9. Return the filter basket and close the lid.

8. MyDolphin™ Plus APP USER GUIDE - LIBERTY 400

8.1 Getting Started with the MyDolphin™ Plus App

The app is compatible with the following smart devices:

- Apple (iOS) – version 10 and up – iPhone, iPad, iPod
 - Android – version 5 and up operating system
1. Ensure Bluetooth® is enabled on your smart device.
 2. Android users - please make sure your GPS and Location Services are ON.
 3. For iOS 13 only - while the app is working, enable Bluetooth® & location.

8.2 Prepare the Pool Cleaner for Connection

Connect the robot to the charger. This turns on the Bluetooth® for pairing.

9. Activate the Pool Cleaner Using your Mobile Phone - LIBERTY 400

1. Activate the MyDolphin™ Plus app.
2. Click Agree and allow all the required permissions.
3. Sign up by creating an account or using your Gmail/Facebook accounts.
4. Select the "Cordless" power source. The app will search for your robot.
5. The app will start pairing with your robot. Please wait until the robot's LED blinks green and you receive a success message in the app.
6. Name your new Dolphin robotic cleaner and you're ready to go. If you start the cleaning cycle via the app, you will get a notification that your robot is at the end of its cleaning cycle.

NOTE: Next time you open the app, you will be prompted to fill in the warranty.

TIP: While pairing, if the app is stuck for over 2 minutes, close the app and retry pairing it.



9.1 MyDolphin™ Plus App Features Guide

Starting the Pool Cleaner Via the App

Tap **Start** and place the robot in the water. You will get a notification when the cycle has finished if you start the pool cleaner via the app.

After starting, the app will show the approximate time remaining in the cycle.



Eco Mode

To easily maintain an already cleaned pool, set the Eco Mode via the app and then place the robot in the water. Eco Mode splits the normal cycle into 2-4 short cycles during the week.

At the end of the week, take the pool cleaner out to rinse the filter basket and recharge the battery. After all of the mini-cycles are finished, or if you call the robot up with the Clicker, the robot will return to its default mode. Set it again in the app every time you want to activate Eco Mode.

There are 3 Eco Modes:

4 x 30 minutes - floor only

3 x 40 minutes - floor only

2 x 60 minutes - floor only



Cleaning Mode

Choose the cycle according to your pool's needs.

Regular - Cleans pool floor, walls, and waterline.

Floor - Cleans pool floor.

Ultra Clean - Cleans all pool surfaces (floor, wall, waterline) more thoroughly.

Robot Error Notification



If there was an error, the app home screen will show the last error. Tap "More information" and the app will guide you to troubleshoot the problem.

10. MyDolphin™ Plus - TROUBLESHOOTING

Symptom	Possible reason	Corrective action
Cannot pair the MyDolphin™ Plus app to the robotic pool cleaner.	<ul style="list-style-type: none"> • The Bluetooth® on one of your devices is either OFF or not in pairing mode. • The mobile phone is too far from the robot. • Mobile phone location is OFF. You did not give the required permissions when installing the app. 	<ul style="list-style-type: none"> • Turn the Bluetooth® off and on in your smartphone. For iOS – Go to settings → Bluetooth®. • Get closer to the robot. • Turn mobile phone location ON • Check that the robot's charger is connected well and that your mobile phone's Bluetooth® is searching for nearby devices. • Try uninstalling and reinstalling the MyDolphin™ Plus app, and give all permissions. If it still doesn't find your robot, try restarting your mobile phone. • If none of the above troubleshooting helps, contact wecare@maytronics.com
Robot is not waiting at the waterline when I arrived. It is standing near a wall.	It waits for a few seconds and then climbs another wall. After climbing 3 walls, it will wait by the wall to prevent running out of energy.	<ul style="list-style-type: none"> • Shake the Clicker in the water for 3 seconds and it should climb up. Clickup will work for 2 days after the end of the robot's cycle. • Connect the provided hook to your cleaning pole, and lift the pool cleaner to the waterline with the hook. At the water line pull the robot out.

Issue	Suggested Action
Robot does not turn ON from the app.	<ul style="list-style-type: none"> • Make sure that the robot is charged with all three LEDs green. • After turning it ON, place it in the water. It is designed not to work outside of the water.

11. ROBOTIC POOL CLEANER - TROUBLESHOOTING

Symptom	Possible reason	Corrective action
The robot does NOT start.	<ul style="list-style-type: none"> An object is stuck in the tracks or wheels. An object or hair is stuck in the impeller. The robot is not fully charged. The robot is out of the water. The red error indicator LED is ON. 	<ul style="list-style-type: none"> Carefully remove the object from tracks or wheels. Clean the impeller (see section 7.1). Charge the battery to 100% -3 green bars. Place the robot in the water within 30 seconds after starting it. If LIBERTY 400, check app for error message and troubleshooting. If none of the above troubleshooting helps, contact wecare@maytronics.com
The robot is moving in circles.	<ul style="list-style-type: none"> Clogged filter basket. Debris stuck in the impeller housing or impeller cover. An object is stuck in the tracks or wheels. The pool's surface is too glossy for this robot model. Algae buildup or pool water does not meet specifications. 	<ul style="list-style-type: none"> Clean the filter basket. It should be white and clean when touching. If it is brown or green, clean it with a hose. If it stays brown, it may be time for a replacement filter. Clean the impeller (see section 7.1). Carefully remove the object from tracks or wheels. Correct pool and water conditions.
The robot doesn't charge properly.	<ul style="list-style-type: none"> The wall power outlet isn't working. An object or dirt is preventing a proper magnetic connection between the charger and the robot. The robot is too hot or cold to be charged properly It hasn't charged for enough time 	<ul style="list-style-type: none"> Test the power outlet with another device or try charging the robot from an outlet that works. Make sure that the charger connections are clean on the robot and magnetic, inductive charger. Charge in the shade or indoors. If summer, try charging at night. It can take up to 6 hours for a full charge.
The robot does not turn or moves in one direction only.	<ul style="list-style-type: none"> Debris stuck in the impeller housing or impeller cover. 	<ul style="list-style-type: none"> Clean the impeller.
The robot moves but does not clean the pool.	<ul style="list-style-type: none"> Clogged filter basket. Debris stuck in the impeller housing or impeller cover. 	<ul style="list-style-type: none"> Clean the filter basket. It should be white. If it is brown or green, clean it with a hose. Clean the impeller.
The robot does not climb up the walls.	<ul style="list-style-type: none"> The filter is too full to allow proper jet propulsion up the wall. Debris is stuck in the impeller housing. The pool surface is too slippery. Algae on walls. Unsuitable pH level. 	<ul style="list-style-type: none"> Clean the filter and make sure that there is nothing stuck in the impeller. The filter should be white. If it is brown or green, clean it with a hose. Clean the impeller. Check the level of chemicals in the water. Improper levels may allow the growth of algae, making the walls slippery. If so, adjust the levels and scrub the walls.

If this troubleshooting guide didn't solve your problem contact Customer Care: wecare@maytronics.com

12. OFF-SEASON STORAGE

Before off-season storage - we recommend charging the battery to about 50% (2 green bars in the battery indicator panel).

Recommended storage temperature range: -10°C - 40°C / 14°F - 104°F.

Storing the robot in a hot location will likely damage the battery.

After off-season storage, charge the robot to its fullest.

Contact Maytronics Customer Care:

North America

- ☎ US 1-888-365-7446
- ☎ Canada 1-855-634-8572
- ✉ customersupport@maytronicsus.com

France

- ☎ +33 (0)4 42 98 14 90
- ✉ support@maytronics.fr

Australia, NZ, South Africa

- ☎ 1 300 693 657
- ✉ infoau@maytronics.com

Rest of the world / Maytronics HQ

- ☎ 00 800 69694141 (toll free number)
- ☎ 00 972 77 96 14 204 (international call)
- ✉ wecare@maytronics.com