

EN



AQUA MARINA

INFLATABLE
STANDUP PADDLE BOARD
USER MANUAL



WARNING

For your own safety and that of your equipment, make sure to take the following precautions. Failure to follow warning notices and instruction may result in property damage, serious injury or death.

GENERAL PADDLING INFORMATION

This manual has been compiled to help you operate your Inflatable Stand Up Paddle Board (Hereinafter referred to as ISUP) with safety and pleasure. It contains details of the ISUP, the equipment supplied, and information on their operation. Please read it carefully and familiarize yourself with the ISUP before using it.

SAFETY

There is a risk of serious injury or death from drowning. Paddle sports can be very dangerous and physically demanding. The user of this product acknowledges, understands, and assumes the risks involved in paddle sports. Observe the following warning labels and safety standards carefully whenever using this product.



AM Official Site



AM HOW-TO Guide



AM Service Center List

WARNING LABEL INSTRUCTIONS



MANDATORY INSTRUCTION

- Wear personal flotation device
- Read instructions first
- Fully inflate all air chambers
- Numbers of users
- Max. load capacity
- Safe distance to shore 150 m (492.1')



PROHIBITION INSTRUCTION

- Do not use in white water (except BT-22RP)
- Do not use in breaking waves (except BT-22WA)
- Do not use in offshore current
- Do not use in offshore wind
- Not for children 14 years old and below (except BT-22VIP)



ATTENTION / DANGER / WARNING

- Design working pressure
- No protection against drowning



MANDATORY INSTRUCTION

- Swimmers only

CN-ORP

Item No.:

Oriental Recreational Products (Shanghai) Co., Ltd.
1699 Daye Road, Fengxian Shanghai, China 201402

PRODUCT SERIAL NUMBER

- Item No.
- Manufacturer information

ALL-AROUND

TOURING

RACING

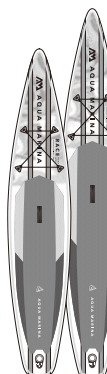

MODEL

BREEZE **VAPOR** **FUSION** **MONSTER**

BT-23BRP BT-23VAP BT-23FUP BT-23MOP

CORAL **BEAST** **MAGMA** **ATLAS**

BT-23COPR BT-23BEP BT-23MAP BT-23ATP
BT-23COPN

**CORAL
TOURING**

BT-23CTPR
BT-23CTPN

HYPER **HYPER**

BT-23HY01 BT-23HY02

RACE **RACE**

BT-21RA01 BT-21RA02

SIZE

9'10" 10'4" 10'10" 12'0"
30" 31" 32" 33"
4.7" 6" 6" 6"

10'2" 10'6" 11'2" 12'0"
31" 32" 33" 34"
4.7" 6" 6" 6"

11'6" 11'6" 12'6"
31" 31" 32"
6" 6" 6"

12'6" 14'0"
27" 27"
6" 6"

300 cm 315 cm 330 cm 366 cm 310 cm 320 cm 340 cm 366 cm
76 cm 79 cm 81 cm 84 cm 78 cm 81 cm 84 cm 86 cm
12 cm 15 cm 15 cm 15 cm 12 cm 15 cm 15 cm 15 cm

350 cm 350 cm 381 cm 381 cm 427 cm
79 cm 79 cm 81 cm 69 cm 69 cm
15 cm 15 cm 15 cm 15 cm 15 cm

FIN

1 SLIDE-IN CENTER FIN

1 SWIFT ATTACH CENTER FIN

1 SWIFT ATTACH RACING FIN

1 SLIDE-IN RACING FIN

VOLUME

229 L 315L 338L 390L

238L 312L 340L 398L

328L 330L 370L

320L 360L

MAX. RIDER WGT

220 LBS 308LBS 330LBS 374LBS
100 KG 140KG 150KG 170KG

231LBS 308LBS 330LBS 396LBS
105KG 140KG 150KG 180KG

286LBS 330LBS 374LBS
130KG 150KG 170KG

330LBS 352LBS
150KG 160KG

MAX. AIR PRESSURE

15 PSI













15 PSI

15 PSI

15 PSI

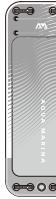
15 PSI /
10 PSI
(center chamber)

18 PSI

	RIVER	SURF	WINDSURF	MULTI-PERSON				FITNESS		FISHING	KID
											
	<p>Yoga Dock BT-23YD Outer Diameter: 290cm/9'6" Inner Diameter: 170cm/67" Thickness: 12cm/4.7"</p> 										
RACE ELITE BT-22RE	RAPID BT-22RP	WAVE BT-22WA	BLADE BT-22BL	SUPER TRIP BT-21ST01	SUPER TRIP TANDEM BT-20ST02	MEGA BT-20ME	AIRSHIP RACE BT-20AS	DHYANA BT-23DHP	PEACE BT-23PC	DRIFT BT-20DRP	VIBRANT BT-22VIP
14'0" 25" 6"	9'6" 33" 6"	8'8" 30" 4"	10'6" 33" 6"	12'2" 32" 6"	14'0" 34" 6"	18'1" 60" 8"	22'0" 34" 8"	10'8" 34" 6"	8'2" 35" 6"	10'10" 38" 6"	8'0" 28" 4"
427 cm 63.5 cm 15 cm	289 cm 84 cm 15 cm	265 cm 75 cm 10 cm	320 cm 84 cm 15 cm	370 cm 82 cm 15 cm	427 cm 86 cm 15 cm	550 cm 152 cm 20 cm	670 cm 87 cm 20 cm	325 cm 86.5 cm 15 cm	250 cm 90 cm 15 cm	330 cm 97 cm 15 cm	244 cm 71 cm 10 cm
1 FIBERGLASS RACING FIN	1 RIVER FIN + 4 FIXED FINS	1 SURF CENTER FIN + 2 SIDE FINS	1 CENTER FIN + 1 DAGGER FIN	1 CENTER FIN	2 CENTER FINS	5 CENTER FINS	1 RACING FIN	1 SWIFT ATTACH / CENTER FIN		1 CENTER FIN	1 CENTER FIN
330L	300L	161L	350L	400L	500L	1400L	1000L	347L	340L	284L	140L
330LBS 150KG	286LBS 130KG	209LBS 95KG	330LBS 150KG	462LBS 210KG	507LBS 230KG	1433LBS 650KG	1014LBS 460KG	341LBS 155KG	330LBS 150KG	286LBS 130KG	132LBS 60KG
18 PSI	18 PSI	18 PSI	18 PSI	15 PSI	18 PSI	8 PSI	18 PSI	15 PSI		15 PSI (board) / 3PSI (side air chambers)	15 PSI

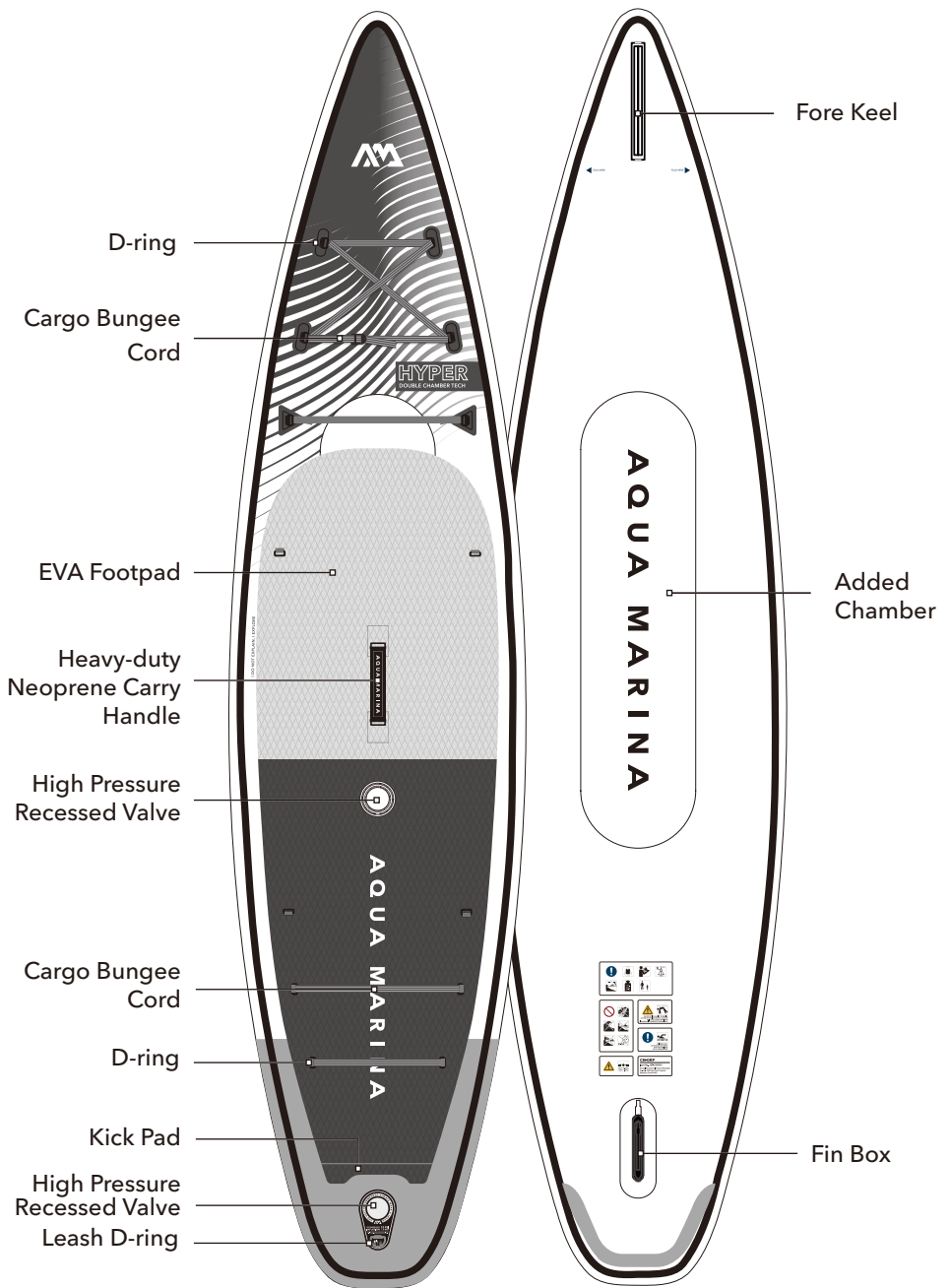

Actual configuration may vary upon different models.

ACCESSORIES

STANDARD

Zip Backpack



Double-action Pump
(Mega/Airship Race/ Super Trip Tandem x 2)



Fin
(Mega x 5/
Super Trip Tandem x 2/
Wave x 3/ Blade x 2)



Cargo Bungee Cord
(except Wave)



Leash
(except Super Trip/ Super Trip Tandem/Mega/
Airship Race/Peace/Yoga Dock)

Repair Kit



***Actual configuration may vary upon different models.**

DRIFT

Fishing Rod Holder x 2

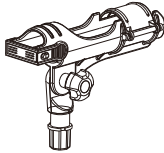

Paddle Holder

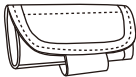

MEGA/YOGA DOCK

Carry Bag



CORAL/CORAL TOURING/YOGA

2-in-1 Carry Strap

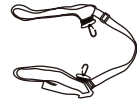

Paddle Holder
(Only for Dhyana)

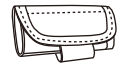

Straps x 3
(Only for Dhyana)



PADDLE

Paddle (excluded from Race/Race Elite/Hyper/Rapid/Super Trip/Mega/
Airship Race/Blade/Wave/Peace/Super Trip Tandem)

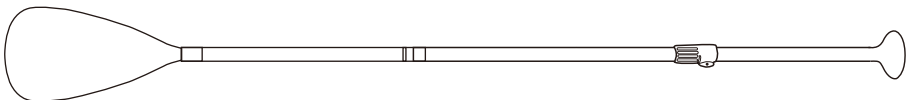

INSTRUCTION FOR ASSEMBLING AND DISASSEMBLING

INFLATION

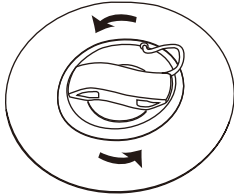

Open the valve cap by twisting counter-clockwise. Ensure the valve is clear from debris, sand, or dirt before releasing.

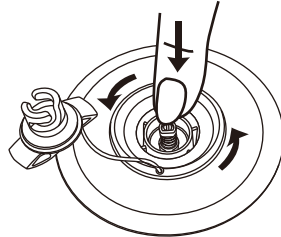

Push valve button in and turn 90 degrees.

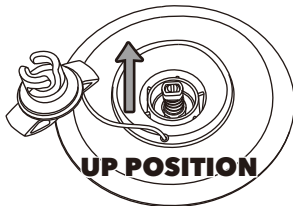

OR

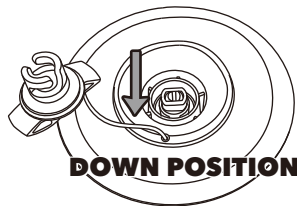

Valve button popping up to the "UP position" for inflation.

Valve button locked in "DOWN position" for deflation.

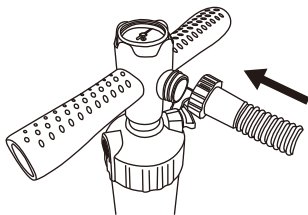

Attach - Attach the pump hose to the pump and secure it tightly.

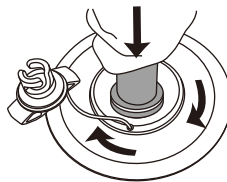

Connect - Attach the end of the pump hose to the valve and twist 45° clockwise to lock in place.

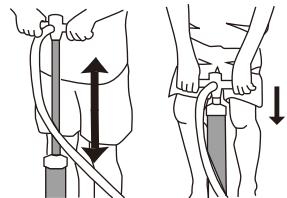

Save Effort - As pressure builds, keep arms extended and bend the knees to power for less effort.

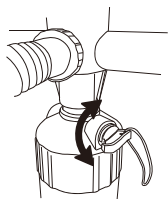

LIQUID AIR V1

Fast Inflation - Use **DOUBLE ACTION** position by closing the air-tap to pump the board up to 7-10 psi.

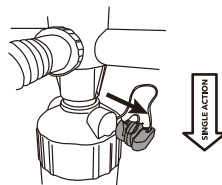
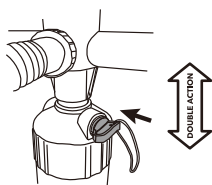

Easy Inflation - Switch to **SINGLE ACTION** position by removing the air-tap for easier inflation.

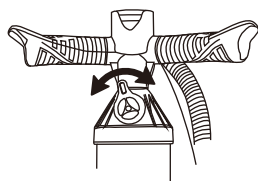

LIQUID AIR V2

Fast Inflation - Use **DOUBLE ACTION** mode with the top cap displaying "2" to pump the board up to 7 - 10 psi.

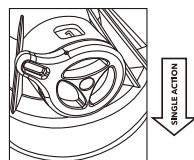
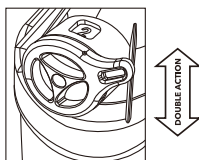

Easy Inflation - Rotate the switch to **SINGLE ACTION** mode with the top cap displaying "1" for easier inflation.

Note: Gauge will not respond until reaching 4psi. Just keep pumping for 2-3 minutes!

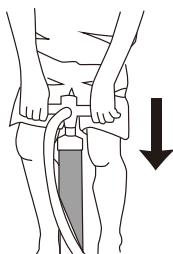

Max. Pressure - Keep pumping the board until you reach 15-18 psi.



12PSI minimum (8PSI for MEGA/ 10PSI for HYPER inner chamber) for proper inflatable boards operation and 15PSI maximum (18PSI for SUPER TRIP TANDEM/ RAPID/ RACE/ RACE ELITE/ WAVE/ BLADE/ AIRSHIP RACE). Over inflation will void your warranty.

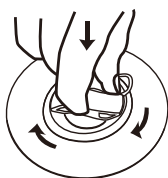

After inflation, return the valve cover and tighten in clockwise direction to lock in place.

Warning:

Do not leave your board under direct sunlight as this may cause over-inflation.

Please keep the board under shade when not in use with a working pressure NO MORE THAN 10psi, or leave your board in a cool dry place.

Remember to check the air pressure before and after use, and deflate your board when necessary.

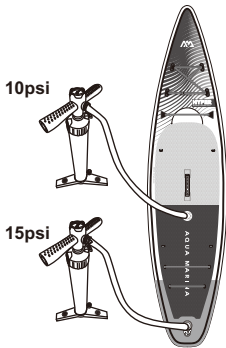

For Double Chamber Board (HYPER)

For best performance, the double chamber should always be inflated to ensure the highest stiffness and safety.

- Inflate the inner chamber up to 10 PSI.
- Inflate the outer chamber up to 15 PSI.

PRECAUTION & TIPS

- Electric Pumps can be used to inflate board up to 80-90%. However, the remaining pressure required should be achieved by using the hand pump to avoid over-inflation.
- Do not use air compressors as this voids warranty of board.
- Before long trips, ensure the board has been inflated and has maintained pressure for a minimum of 24 hours.

FIN INSTALLATION

Slide-in Center Fin System

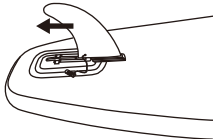

SLIDE - Slide in the large Center Fin to the fin base.

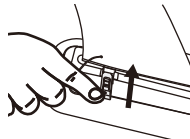

INSERT - Insert the push-in pin.

Swift Attach Fin System

(CORAL / BEAST / MAGMA / ATLAS / CORAL TOURING / HYPER / WAVE / DHYANA)

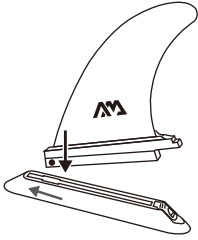

SLOT IN - Align the fin base into the fin box slot and slide to the front edge.

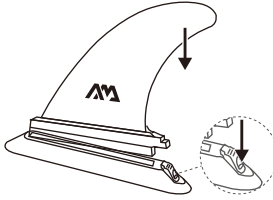

PRESS - Keep pressing the lever on the rear and push the fin down.

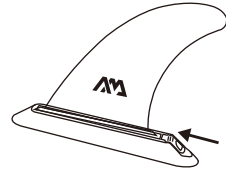

SNAP - Lock the fin in place with the snap.

NOTE: Install the WAVE side fins as suggested below.

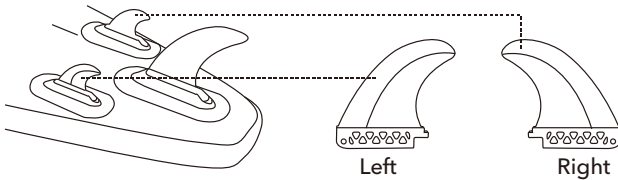

US Fin System (RACE ELITE)

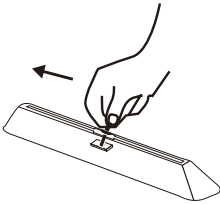

WASHER - Place the washer into the fin box and slide it to the front.

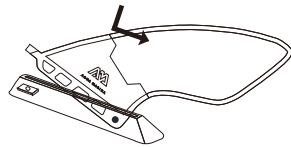

SLOT IN - Align the fin base into the fin slot and slide to the rear of the fin box.

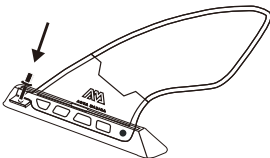

LINE UP - Push the fin down and line up the washer hole with the screw.

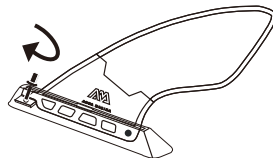

SCREW - Secure firmly by screwing.

DEFLATION

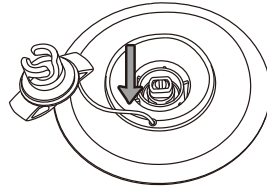
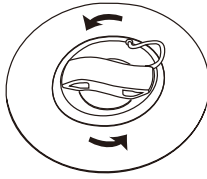

Valve Open - Open the valve cap and twist the valve button for "DOWN POSITION". Ensure the valve is clear from debris, sand, or dirt before releasing.



Deflate (by hands) - Roll the board from nose to tail to squeeze the air out.

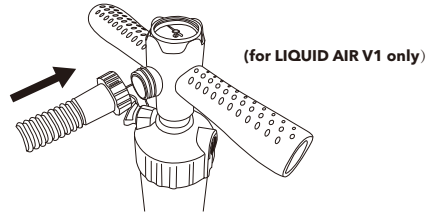

Deflate (by pump) - Use the pump on "DEFLATE" position.

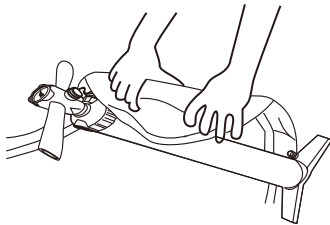

Roll - Roll the board around the pump. Make sure the pump is settled in the middle.

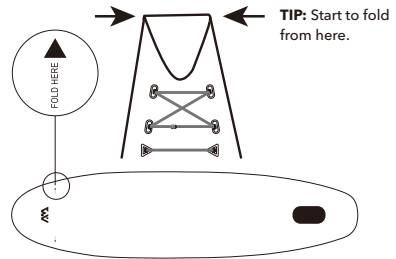

or

Roll - Follow the folding line indication for first fold, and roll the board from nose to tail.

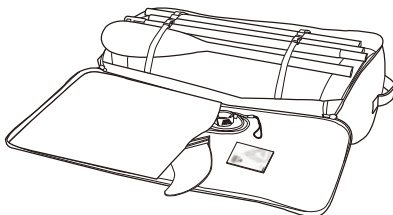

Pack - Use the webbing strap to secure the neatly rolled board in place, but do not overtighten the strap. Place the accessories in the pocket.

YOGA DOCK INSTRUCTION

YOGA DOCK and DHYANA Connection

Each DHYANA yoga board can be connected to this YOGA DOCK by three straps. For each strap, follow connection instruction shown below.

1. Link up the clasp (a) with D-ring (b) on the board. Thread the strap through D-ring (c) on the dock.
2. Thread the strap through the buckle (d) and fasten.
3. Repeat above steps for the rest straps.

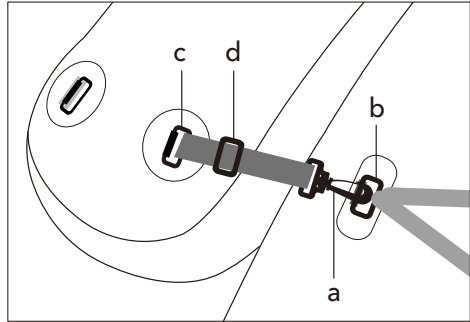

Folding and Storage

1. Fold the Yoga Dock as shown below.
2. Pack the Yoga Dock into the carry bag.

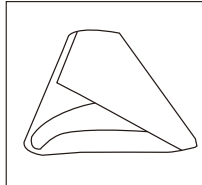
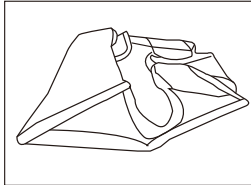
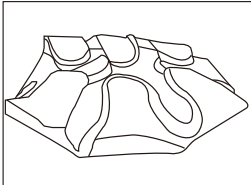

PADDLE ASSEMBLY

1



Correct



Incorrect



Front

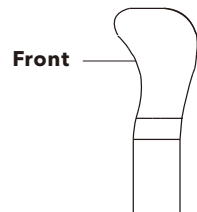

Front

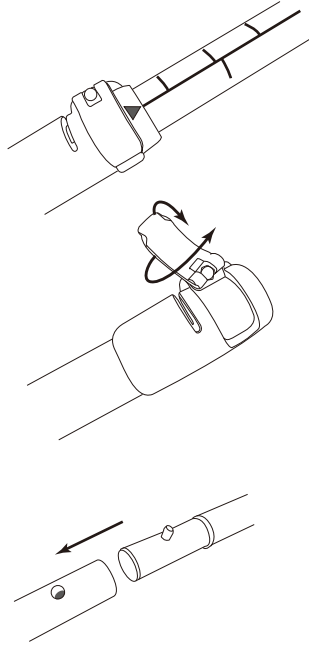
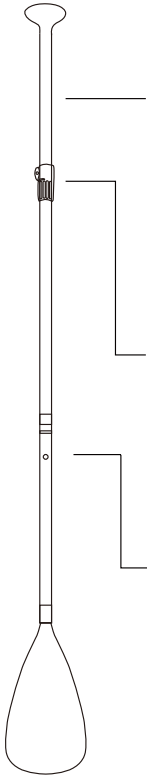

Ensure the center line of the scale is aligned with the indicator on clamp.

CLAMP SYSTEM

Adjust tightness by rotating the hasp to reduce any play.

SPRING PIN SYSTEM

Secure spring pin.

NOTE: Always drain the water left in the paddle shaft after each use.

3 PCS ADJUSTABLE

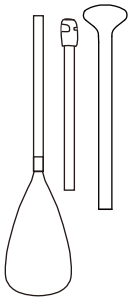

- **ACE** B0303622
Adjustable Aluminum iSUP Paddle for Kids
- **SPORTS III** B0303922
Adjustable Aluminum iSUP Paddle
- **PASTEL** B0303923/24/25
Fiberglass / Carbon iSUP Paddle
- **SOLID** B0303013
Fiberglass iSUP Paddle
- **CARBON GUIDE** B0303014
Carbon / Fiberglass iSUP Paddle
- **CARBON PRO** B0303015
Carbon iSUP Paddle

2 PCS ADJUSTABLE

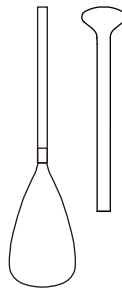

- **CARBON X**
B0303016
2PCS Carbon iSUP Paddle

2-IN-1

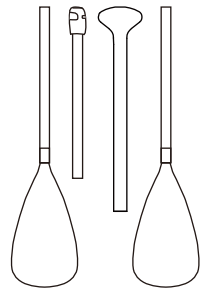

- **DUAL-TECH**
B0303011
2-in-1 iSUP & Kayak Paddle

HOW TO WEAR A SAFETY LEASH

WAIST



RIVER LEASH
B0303025

ANKLE



COIL LEASH
B0303930



SURF LEASH
B0303024



STANDARD LEASH
B0303929

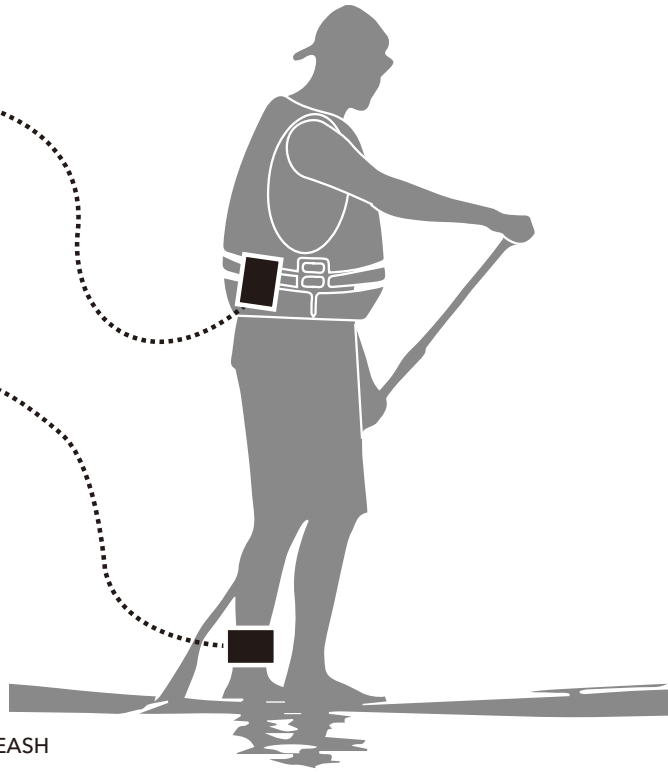

STANDARD LEASH INSTALLATION

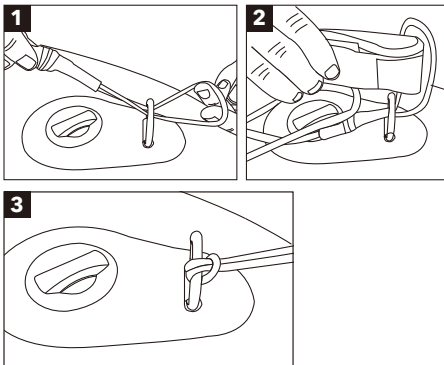

COIL/SURF/RIVER LEASH INSTALLATION

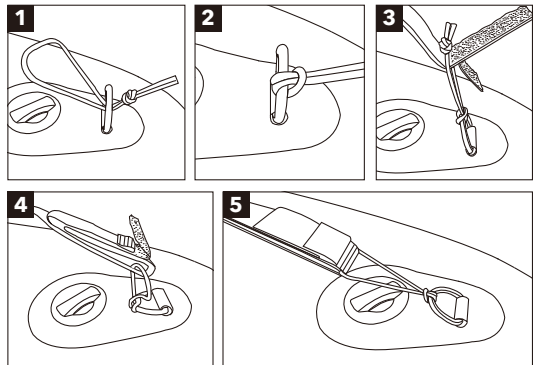

HOW TO TAKE CARE OF ISUP BOARD

DO'S

CLEANING

Clean the board after each use with freshwater and mild soap.



KEEP IT DRY

Dry the board after each use, especially before storing to avoid mould damage.



FREQUENT USE

Use the board frequently as long-term storage may cause adhesive failure.



REGULAR MAINTENANCE

Regularly check for cracks, scrapes, or any other issues and repair if necessary.



DON'TS

DON'T USE AN AIR COMPRESSOR

You can easily over-inflate the board by using an air compressor and void the warranty.



NO DRAGGING

Don't drag the board as sharp debris may puncture it.



AVOID DIRECT SUNLIGHT

Keep the board under shade when not in use with a working pressure less than 50%-60% of the max. air pressure.



AVOID TEMPERATURE EXTREMES

Keep the boards sheltered away from temperature extremes and humidity. Store at room temperature between 0°C - 40°C.



FAQs (Frequently Asked Questions)

Q: How much air should I pump into my board, and how long does it take to inflate?

A: The maximum pressure is 15 - 18 PSI (8 PSI for MEGA, 10 PSI for HYPER inner chamber, 3 PSI for DRIFT side chambers), any higher you risk over inflating and damage. Depending on the size of your board it can take anywhere from 5 to 8 minutes.

Q: When detaching the pump from the board, the air starts to release from the valve. How do I stop this from happening?

A: The air is releasing as the valve spring pin has been left in the deflating position. Simply push down and turn the pin until it lifts up into the inflation position and stops air from releasing; continue to inflate the board until up to pressure.

HOW TO REPAIR A CUT OR PUNCTURE IN YOUR INFLATABLE BOARD

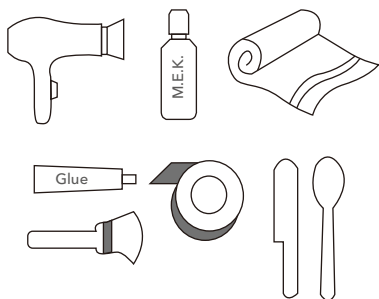

SUPPLIES REQUIRED

- Glue (AQUASEAL® is recommended)
- Acetone or methyl ethyl ketone (M.E.K.)
- Hairdryer
- Brush
- Tape
- Spatula or spoon
- Towel

(Not provided in the SUP board package)



1

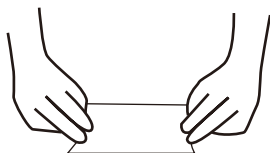

2

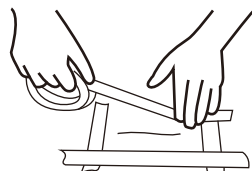

3

1. Clean the area around the cut or puncture using acetone or M.E.K.
2. Draw the outline of the patch using chalk or pencil (do not use ink).
Cut the patch, cover the cut or puncture with approximately 2.5cm (1 inch) overlap on all sides.
3. Apply tape along the outline of the patch. This will prevent the glue from spreading outside the patch area.

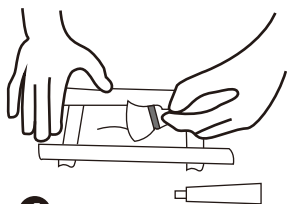

4

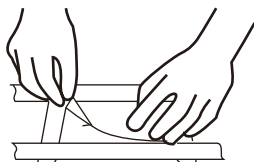

5

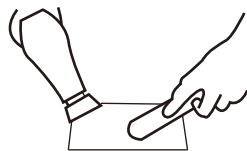

6

4. Apply glue on both the board and patch using a brush or other applicator. Make sure the glue is spread evenly and completely over the board and patch. Let the glue dry for 5 minutes.

5. Apply the patch starting on one side and move towards the other side
Be careful not to trap any air bubbles.
6. Use a hairdryer to gently heat the area to ensure a good bond between the patch and the board.
Use a metal spatula or spoon and firm pressure to ensure a good bond and to remove any air bubbles.

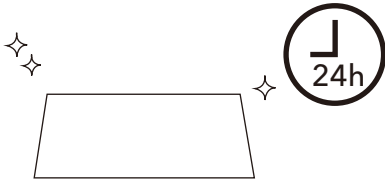

Allow the glue to cure with the board un-inflated for 24 hours prior to use.

HOW TO FIX A LEAKING VALVE

A. Try to tighten the valve

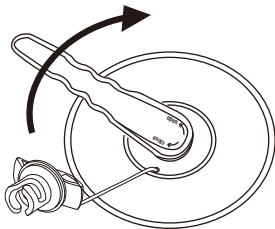

1. Inflate your board up to the max air pressure
2. Stick your valve wrench down inside of valve and turn clockwise to tighten the valve back down onto the board

B. Re-install or replace a valve

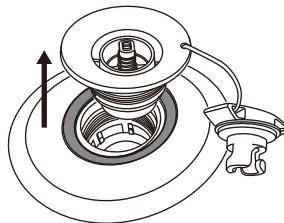
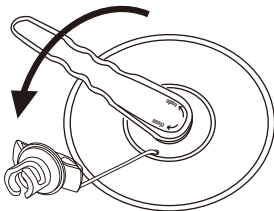

1. Completely deflate your board
2. Undo the dust cap and insert the valve wrench into the valve and twist counterclockwise to remove the valve

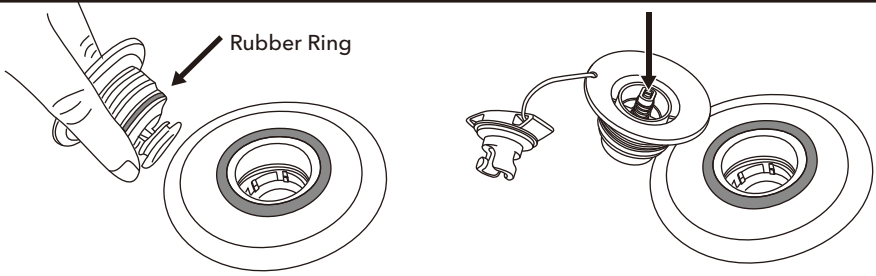

3. Check the rubber ring to make sure that it is in the correct position, tight around the valve and there is no debris in the way
4. Be sure the pin spring is functioning properly and that there are no cracks along the edges

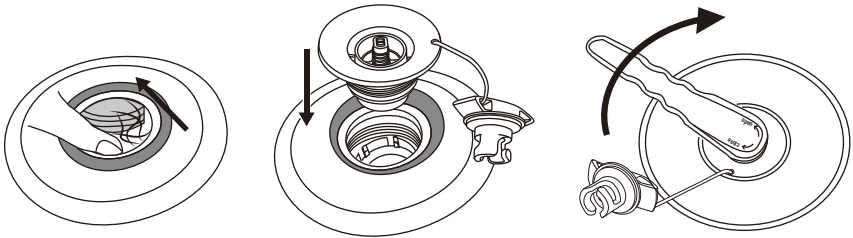

5. Ensure there are no strings from the drop stitching material
6. Note the bottom piece of the valve is not attached to anything
7. Fit the valve back into your board
8. Align all the threads and twist to tighten
9. Once the valve is hand tight, use the valve wrench to seal completely



NOTE: Correctly use the wrench by pressing it with one hand on top.

WARRANTY

**2
YEAR**

AM warrants this product to be free from major defects in material or workmanship to the original purchaser for a period of **2-year** (board ONLY) from the date of purchase. This warranty is subject to the following limitations.

1. The warranty is valid only when this product is used for normal recreational activities and does not cover products used in rental or school operations.
2. AM will make the final warranty determination, which may require inspection and/or photos of the equipment, which clearly show the defect(s). If necessary, this information must be sent to the AM distributor in your country with prepaid postage. Product can be returned only if a return authorization number is given in advance by the AM distributor. The return authorization number must be clearly labelled on the outside of the package, or it will be refused.
3. If a product is deemed to be defective by AM, the warranty covers the repair or replacement of the defective product only. AM will not be responsible for any costs, losses, or damages incurred as a result of loss or misuse of this product.
4. This warranty does not cover damage caused by misuse, abuse, neglect, normal wear and tear including, but not limited to punctures, damage due to excessive heat exposure, damage caused by improper handling and storage, damage caused by use in waves or shore break, board breakage caused by filling or crashing in surf conditions, or damage caused by anything other than defects in material and workmanship.
5. This product must not be modified and/or fitted with a motor except AM BlueDrive power fin.
6. This product must not be used in excess of the manufacturers recommended maximum load capacity.
7. This warranty is void if any unauthorized repair, change or modification has been made to any part of the equipment.
8. The warranty for any repaired or replacement equipment is good from the date of the original purchase only.
9. The original purchase receipt must accompany all warranty claims. The name of the retailer and date of purchase must be clear and legible.
10. There are no warranties that extend beyond the warranty specified here in.



WARNING

This product is designed in accordance with standards for a specific use. Any modifications or transformations higher than that indicated by the manufacturer could result in serious risks for the user and will void the warranty.

FR



AQUA MARINA

GONFLABLE
PLANCHE DE STANDUP PADDLE

**MANUEL DE
L'UTILISATEUR**



ATTENTION

Pour votre propre sécurité et celle de votre équipement, assurez-vous de prendre les précautions suivantes. Le non-respect des avertissements et des instructions peut entraîner des dommages matériels, des blessures graves ou la mort.

INFORMATIONS GÉNÉRALES D'UTILISATION

Cette notice a été conçue pour vous aider à utiliser votre planche gonflable de stand up paddle (ci-après dénommé ISUP) en sécurité et avec plaisir. Il contient des détails de l'ISUP, les équipements fournis, et des informations sur leur fonctionnement. Veuillez le lire attentivement afin de vous familiariser avec l'ISUP avant de l'utiliser.

SÉCURITÉ

Il y a un risque de blessure grave ou de mort par noyade. Les sports de pagaie peuvent être très dangereux et très exigeants physiquement. L'utilisateur de ce produit reconnaît, comprend et assume les risques liés aux sports de pagaie. Veuillez respecter les étiquettes d'avertissement et les normes de sécurité suivantes lorsque vous utilisez ce produit.



Site officiel de AM



Guide de AM HOW-TO



Liste des centres
de service AM

ETIQUETTES D'AVERTISSEMENT



INSTRUCTIONS OBLIGATOIRES



- Porter un gilet de sauvetage
- Lire les instructions en premier
- Gonfler complètement toutes les compartiments à air
- Nombre d'utilisateurs
- Max. capacité de chargement
- Distance de sécurité à la rive 150 m (492.1 pi)



INTERDICTIONS



- Ne pas utiliser en eau vive (sauf BT-22RP)
- Ne pas utiliser dans les vagues déferlantes (sauf BT-22WA)
- Ne pas utiliser avec courant au large
- Ne pas utiliser dans le vent au large
- Non destinée aux enfants de 14 ans et au dessous (sauf BT-22VIP)



ATTENTION / DANGER / AVERTISSEMENT

- Conception pression de fonctionnement
- Pas de protection contre la noyade



INSTRUCTIONS OBLIGATOIRES

- Nageurs seulement

CN-ORP

Item No. _____

Oriental Recreational Products (Shanghai) Co., Ltd.
1699 Daye Road, Fengxian Shanghai, China 201402

NUMERO DE SÉRIE

- Numéro d'article
- Informations sur le fabricant

ALL-AROUND



TOURING



COURSES

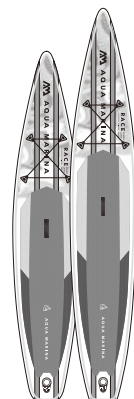

MODÈLE

BREEZE	VAPOR	FUSION	MONSTER	CORAL	BEAST	MAGMA	ATLAS	CORAL TOURING	HYPER	HYPER	RACE	RACE
BT-23BRP	BT-23VAP	BT-23FUP	BT-23MOP	BT-23COPR BT-23COPN	BT-23BEP	BT-23MAP	BT-23ATP	BT-23CTPR BT-23CTPN	BT-23HY01	BT-23HY02	BT-21RA01	BT-21RA02

TAILLE

9'10"	10'4"	10'10"	12'0"	10'2"	10'6"	11'2"	12'0"	11'6"	11'6"	12'6"	12'6"	14'0"
30"	31"	32"	33"	31"	32"	33"	34"	31"	31"	32"	27"	27"
4.7"	6"	6"	6"	4.7"	6"	6"	6"	6"	6"	6"	6"	6"
300 cm	315 cm	330 cm	366 cm	310 cm	320 cm	340 cm	366 cm	350 cm	350 cm	381 cm	381 cm	427 cm
76 cm	79 cm	81 cm	84 cm	78 cm	81 cm	84 cm	86 cm	79 cm	79 cm	81 cm	69 cm	69 cm
12 cm	15 cm	15 cm	15 cm	12 cm	15 cm	15 cm	15 cm	15 cm	15 cm	15 cm	15 cm	15 cm

AILERON

1 AILERON CENTRAL COULISSANT

1 AILERON CENTRAL À FIXATION RAPIDE

1 AILERON DE COURSE À FIXATION RAPIDE

1 PALME DE COURSE

VOLUME

229 L	315L	338L	390L	238L	312L	340L	398L	328L	330L	370L	320L	360L
-------	------	------	------	------	------	------	------	------	------	------	------	------

POIDS MAXIMUM DE L'UTILISATEUR

220 LBS	308LBS	330LBS	374LBS	231LBS	308LBS	330LBS	396LBS	286LBS	330LBS	374LBS	330LBS	352LBS
100 KG	140KG	150KG	170KG	105KG	140KG	150KG	180KG	130KG	150KG	170KG	150KG	160KG

PRESSION MAXIMALE DE L'AIR

15 PSI











15 PSI

15 PSI

15 PSI

15 PSI /
10 PSI
(chambre centrale)

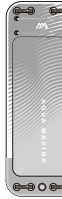
18 PSI

	RIVIÈRE	SURF	VOILE	MULTI-PERSONNE				FITNESS		PÊCHE	ENFANT
											
RACE ELITE BT-22RE	RAPID BT-22RP	WAVE BT-22WA	BLADE BT-22BL	SUPER TRIP BT-21ST01	SUPER TRIP TANDEM BT-20ST02	MEGA BT-20ME	AIRSHIP RACE BT-20AS	DHYANA BT-23DHP	PEACE BT-23PC	DRIFT BT-20DRP	VIBRANT BT-22VIP
14'0" 25" 6"	9'6" 33" 6"	8'8" 30" 4"	10'6" 33" 6"	12'2" 32" 6"	14'0" 34" 6"	18'1" 60" 8"	22'0" 34" 8"	10'8" 34" 6"	8'2" 35" 6"	10'10" 38" 6"	8'0" 28" 4"
427 cm 63.5 cm 15 cm	289 cm 84 cm 15 cm	265 cm 75 cm 10 cm	320 cm 84 cm 15 cm	370 cm 82 cm 15 cm	427 cm 86 cm 15 cm	550 cm 152 cm 20 cm	670 cm 87 cm 20 cm	325 cm 86.5 cm 15 cm	250 cm 90 cm 15 cm	330 cm 97 cm 15 cm	244 cm 71 cm 10 cm
1 AILERON DE COURSE EN FIBRE DE VERRE	1 PALME DE RIVIÈRE + 4 PALME FIXES	1 AILERON CENTRAL DE SURF + 2 AILERONS LATÉRAUX	1 PALME DAGGER + 1 PALME CENTRE	1 PALME CETER	2 PALME CETER	5 PALME CETER	1 PALME DE COURSE	1 AILERON CENTRAL À FIXATION RAPIDE /		1 PALME CETER	1 PALME CETER
330L	300L	161L	350L	400L	500L	1400L	1000L	347L	340L	284L	140L
330LBS 150KG	286LBS 130KG	209LBS 95KG	330LBS 150KG	462LBS 210KG	507LBS 230KG	1433LBS 650KG	1014LBS 460KG	341LBS 155KG	330LBS 150KG	286LBS 130KG	132LBS 60KG
18 PSI	18 PSI	18 PSI	18 PSI	15 PSI	18 PSI	8 PSI	18 PSI	15 PSI		15 PSI (panneau) / 3PSI (chambres à air latérales)	15 PSI

Yoga Dock BT-23YD
Diamètre extérieur: 290cm/9'6"
Diamètre intérieur: 170cm/67"
Épaisseur: 12cm/4.7"



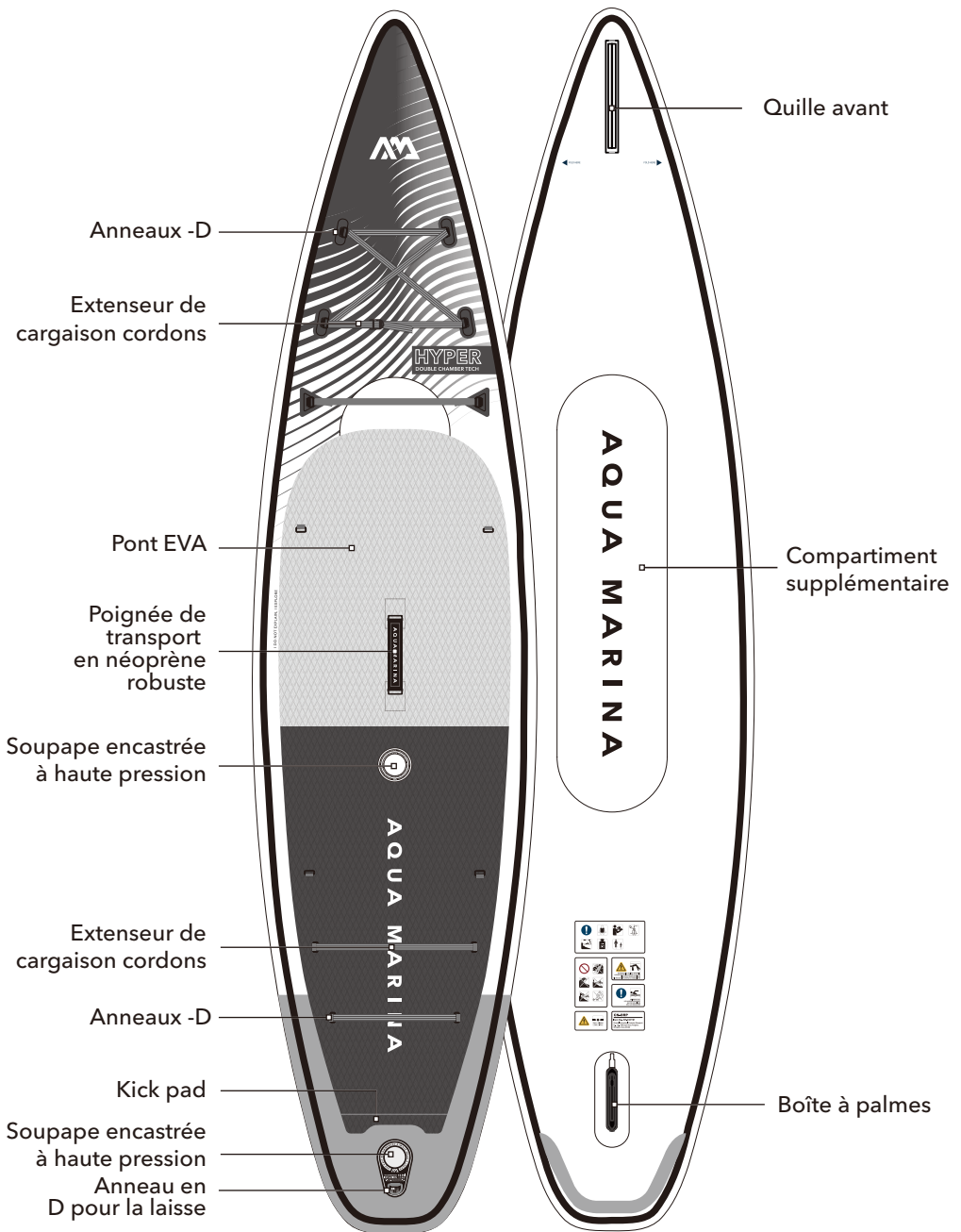

La configuration réelle peut varier selon les modèles.

ACCESSOIRES

STANDARD

Sac à dos zippé



Pompe double-Action
(Mega/Airship Race/ Super Trip Tandem x 2)



Aileron central
(Mega x 5/
Super Trip Tandem x 2/
Wave x 3/ Blade x 2)



Cordon cargo
(sauf Wave)



Kit de réparation



Leash
(except Super Trip/ Super Trip Tandem/Mega/
Airship Race/Peace/Yoga Dock)

***La configuration réelle peut varier selon les modèles.**

DRIFT

Porte-canne à pêche x 2

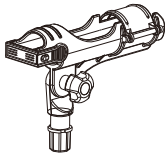

Porte-palette

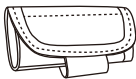

MEGA/YOGA DOCK

Sac de transport



CORAL/CORAL TOURING/YOGA

Sangle de bord

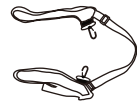

Porte-palette
(Uniquement pour Dhyana)



Sangles x 3
(Uniquement pour Dhyana)



PAGAIE

Pagaie (sauf Race/Race Elite/Hyper/Rapid/Super Trip/Mega/
Airship Race/Blade/Wave/Peace/Super Trip Tandem)

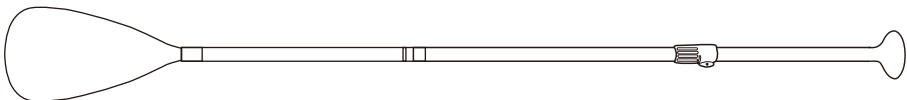

INSTRUCTIONS POUR LE MONTAGE ET DE DEMONTAGE

GONFLAGE

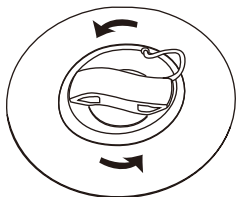

Ouvrez le bouchon de la valve en le dévissant dans le sens inverse des aiguilles d'une montre. Assurez-vous que la valve ne contient pas de débris, de sable ou de saleté avant de la desserrer.

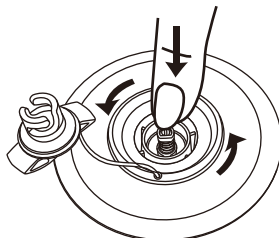

Appuyez sur le bouton de la valve et tournez-le de 90 degrés.

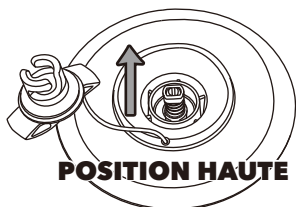

OU

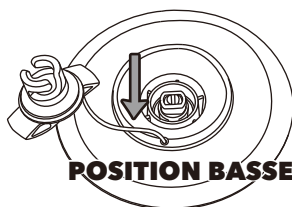

Bouton de la valve en position "UP" pour gonfler.

Bouton de la valve verrouillé en position "DOWN" pour dégonfler.

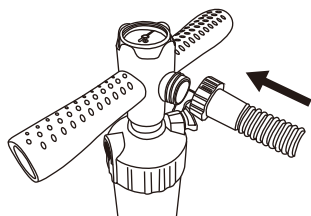

Attacher - Raccordez le tuyau de la pompe à celle-ci et serrer à fond.

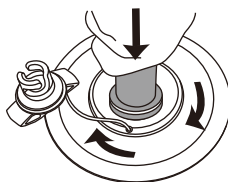

Connexion - Attachez l'extrémité du tuyau de la pompe à la valve et tournez la valve de 45° dans le sens des aiguilles d'une montre pour la verrouiller en place.

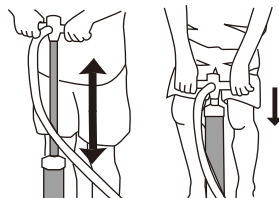

Faites moins d'efforts - Lorsque la pression monte, gardez les bras tendus et pliez les genoux pour faire moins d'efforts.

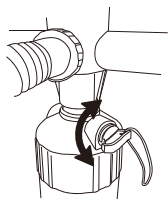

LIQUID AIR V1

Gonflage rapide - Utilisez la position **DOUBLE ACTION** en fermant le robinet d'air pour gonfler la planche jusqu'à 7-10 psi.

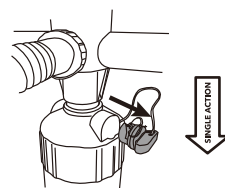
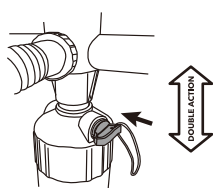

Gonflage facile - Passez en position **SINGLE ACTION** en retirant le robinet d'air pour un gonflage plus facile.

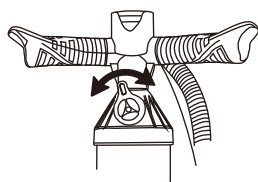

LIQUID AIR V2

Gonflage rapide - Utilisez le mode **DOUBLE ACTION** avec le bouchon supérieur affichant "2" pour gonfler la planche jusqu'à 7 - 10 psi.

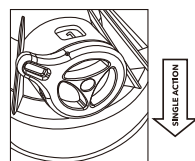
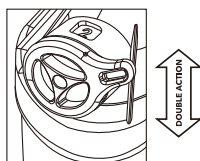

Gonflage facile - Tournez l'interrupteur en mode **SINGLE ACTION** avec le capuchon supérieur affichant "1" pour un gonflage plus facile.

Remarque: la jauge ne répondra pas avant d'avoir atteint une pression de 4psi. Continuez à pomper pendant 2-3 minutes !

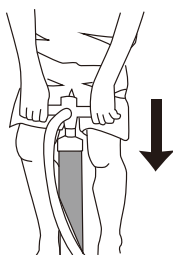

Pression max. - Continuez à pomper la planche jusqu'à atteindre 15-18 psi.



12PSI minimum (8PSI pour MEGA / 10PSI pour la chambre intérieure HYPER) pour des planches gonflables convenables fonctionnement et 15PSI maximum (18PSI pour SUPER TRIP/TANDEM/ RAPID/ RACE/ RACE ELITE/WAVE/ BLADE/ AIRSHIP RACE). Surgonflage doit être évité pour la Sécurité. Connectez le tuyau de la pompe au boîtier de la jauge et fixez-le fermement.

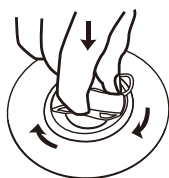

Après le gonflage, remettez le capuchon de la valve et serrez-le dans le sens des aiguilles d'une montre pour le bloquer à sa place.

Attention:

Ne laissez pas votre planche en plein soleil, car cela pourrait entraîner un surgonflage. Veuillez garder la planche à l'ombre lorsqu'elle n'est pas utilisée avec une pression d'utilisation.

Ne pas dépasser 10psi, ou laissez votre planche dans un endroit frais et sec. N'oubliez pas de vérifier la pression d'air avant et après utilisation, et dégonflez votre planche si nécessaire.

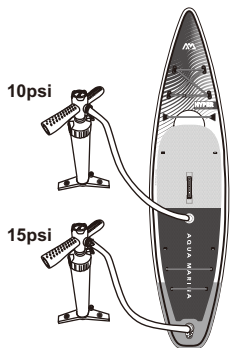

Pour la planche à double compartiment (HYPER)

Pour de meilleures performances, tous Les 2 compartiments doivent être gonflée pour assurer la meilleure rigidité une sécurité optimale.

- Gonflez la chambre intérieure jusqu'à 10 PSI.
- Gonflez la chambre extérieure jusqu'à 15 PSI.

PRECAUTION ET CONSEILS

- Les pompes électriques peuvent être utilisées pour gonfler une planche jusqu'à 80-90%. Pour le reste du gonflage, veuillez utiliser la pompe à main pour éviter le sur-gonflage.
- Ne pas utiliser des compresseurs d'air car cela pourra endommager la planche.
- Avant de longs trajets, assurez-vous que la planche a été gonflée et qu'elle a gardé la pression pendant au moins 24 heures.

INSTALLATION DE L'AILERON

Système d'aileron central coulissant

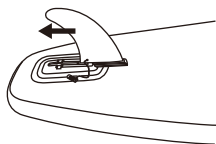

GLISSER - Faites glisser le gros aileron central pour le pincer sur sa base.

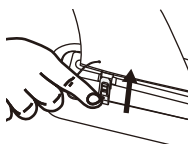

INSEREZ - Insérer la broche d'insertion.

Système de palmes de type fixation rapide

(CORAL / BEAST / MAGMA / ATLAS / CORAL TOURING / HYPER / WAVE / DHYANA)

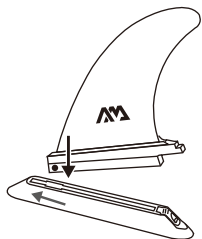

INSERTION - Alignez la base de l'aileron dans la fente de la boîte à ailerons et faites-la glisser jusqu'au bord avant.

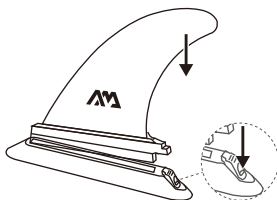

PRESSER - Maintenez la pression sur le bouton situé à l'arrière et appuyez sur l'aileron vers le bas.

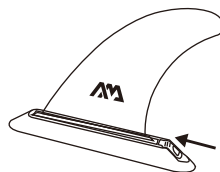

ACCROCHAGE - Verrouillez l'aileron en place avec le crochet.

REMARQUE: Installez les ailerons latéraux WAVE comme indiqué ci-dessous.

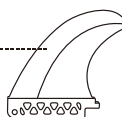
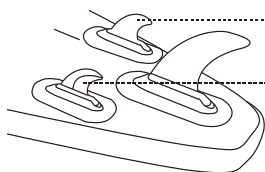

Gauche

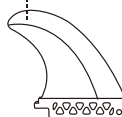

Droite

Système d'aileron US (RACE ELITE)

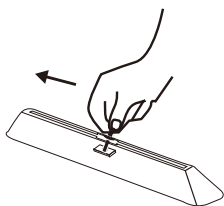

RONDELLE - Placez la rondelle dans la boîte à ailerons et faites-la glisser vers l'avant.

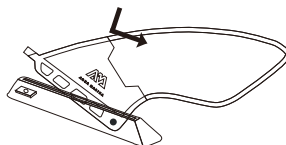

INSERTION - Alignez la base de l'aileron dans la fente de l'aileron et faites-la glisser vers l'arrière du boîtier de l'aileron.

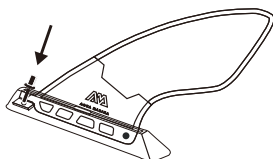

ALIGNEMENT - Poussez l'aileron vers le bas et alignez le trou de la rondelle avec la vis.

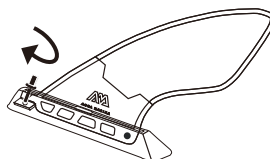

VISSAGE - Fixez solidement en vissant.

DEGONFLAGE

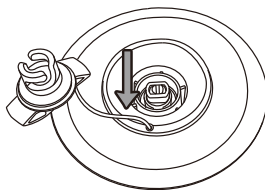
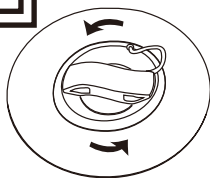

Ouverture de la valve - Ouvrez le capuchon de la valve et tournez le bouton de la valve en "POSITION BASSE". Assurez-vous que la valve n'est pas couverte de débris, de sable ou de saleté avant de la relâcher.



Dégonflage (avec les mains) - Faites rouler la planche depuis l'arrière vers la valve pour faire sortir l'air.

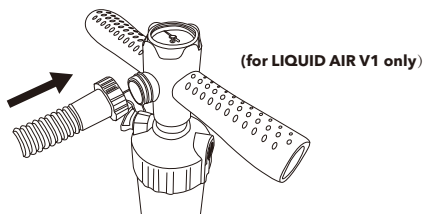

Dégonflage (avec la pompe) - Utilisez la pompe en position "DEFLATE".

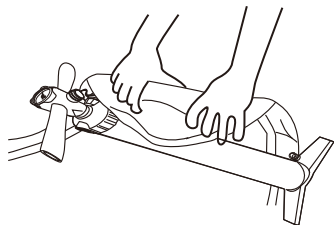

Enrouler - Enroulez la planche autour de la pompe. Veillez à ce que la pompe soit placée au milieu.

OU

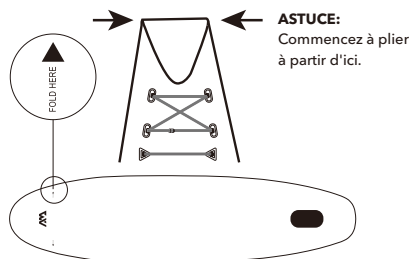

Enrouler - Suivez l'indication de la ligne de pliage pour le premier pli, et enroulez ensuite la planche de la pointe à la queue.

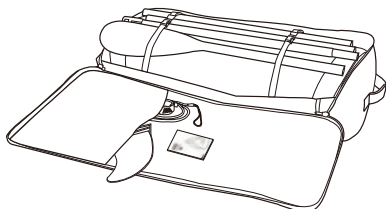

Emballage - Utilisez la sangle pour maintenir en place la planche soigneusement enroulée, mais ne serrez pas trop la sangle. Placez les accessoires dans la pochette.pocket.

INSTRUCTIONS POUR LE YOGA DOCK

Connexion du YOGA DOCK et du DHYANA

Chaque planche de yoga DHYANA peut être connectée à ce YOGA DOCK à l'aide de trois sangles.

Pour chaque sangle, il faut suivre les instructions de connexion indiquées ci-dessous.

1. Reliez le crochet (a) à l'anneau en D (b) de la planche. Faites passer la sangle dans l'anneau en D (c) du dock.
2. Faites passer la sangle dans la boucle (d) et fixez-la.
3. Répétez les étapes ci-dessus pour les autres sangles.

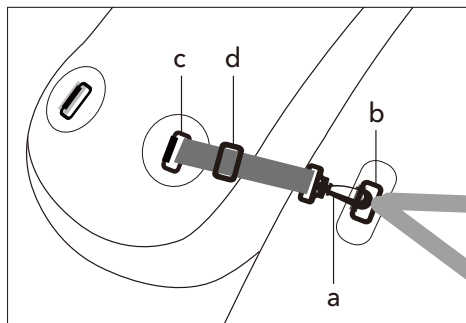

Pliage et rangement

1. Pliez le Yoga Dock comme indiqué ci-dessous.
2. Rangez le Yoga Dock dans son sac de transport.

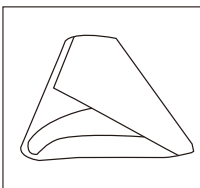
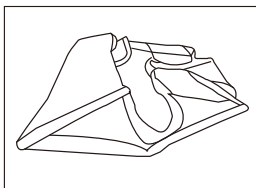
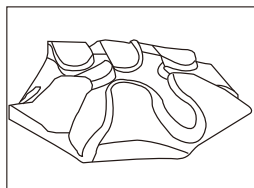

ASSEMBLAGE DE LA PAGAIE

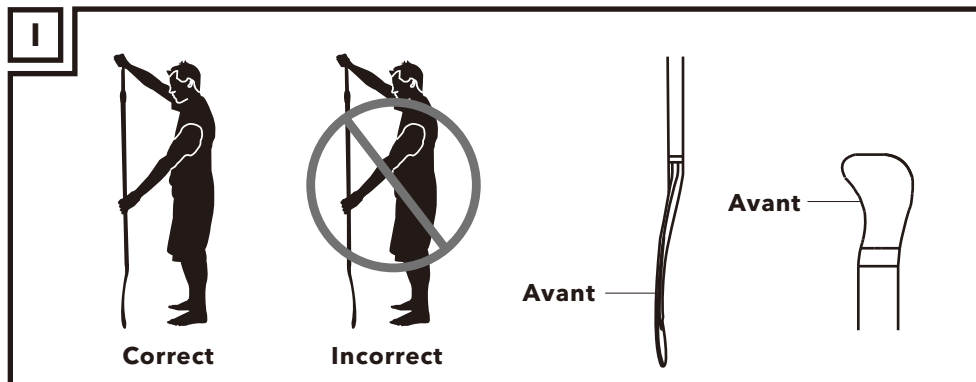

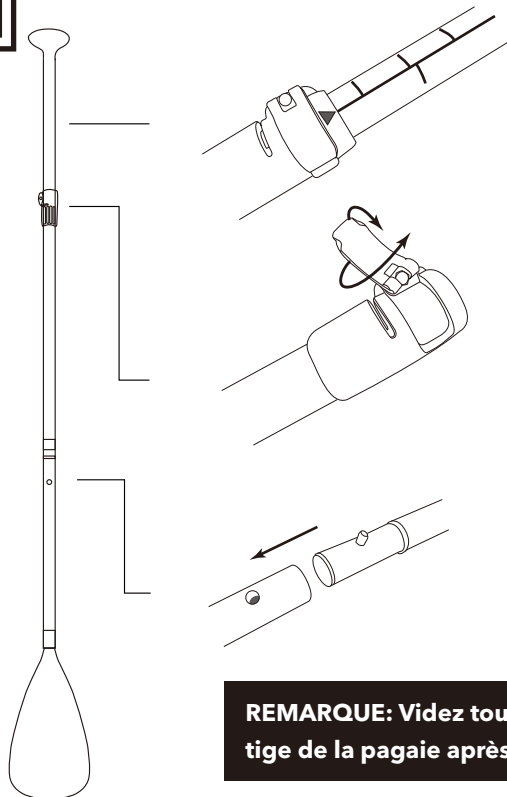

Assurez-vous que la ligne centrale de la balance est alignée avec l'indicateur de la pince.

SYSTÈME DE PINCE

Réglez le serrage en faisant tourner le morillon pour réduire un éventuel jeu.

SYSTÈME DE GOUPILLE À RESSORT

Fixation de la goupille Élastique.

REMARQUE: Videz toujours l'eau qui reste dans la tige de la pagaie après chaque utilisation.

3 PIÈCES RÉGLABLES

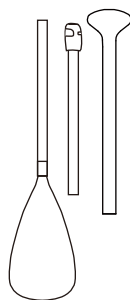

- **ACE** B0303622
Pagaie iSUP ajustable en aluminium pour enfants
- **SPORTS III** B0303922
iSUP alu réglable pagaie
- **PASTEL** B0303923/24/25
Pagaie iSUP en fibre de verre / carbone
- **SOLID** B0303013
iSUP Fibre réglable pagaie
- **CARBON GUIDE** B0303014
iSUP carbone/fibres de verre pagaie
- **CARBON PRO** B0303015
Pagaie iSUP carbone

2 PIÈCES RÉGLABLES

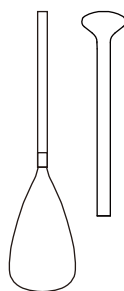

- **CARBON X**
B0303016
Pagaie iSUP 2 parties en carbone

2-EN-1

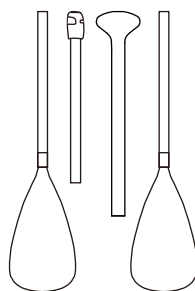

- **DUAL-TECH**
B0303011
2-en-1 iSUP & pagaie de kayak

COMMENT PORTER UN LEASH DE SÉCURITÉ

TAILLE



LEASH POUR RIVIÈRE
B0303025

CHEVILLE



LEASH BOBINE
B0303930



LEASH DE SURF
B0303024



LEASH STANDARD
B0303929

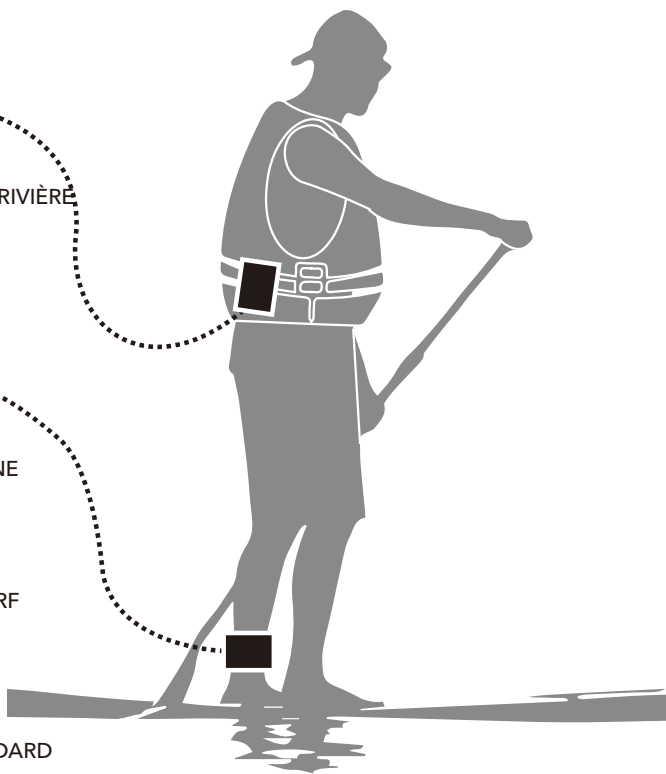

INSTALLATION DE LEASH STANDARD

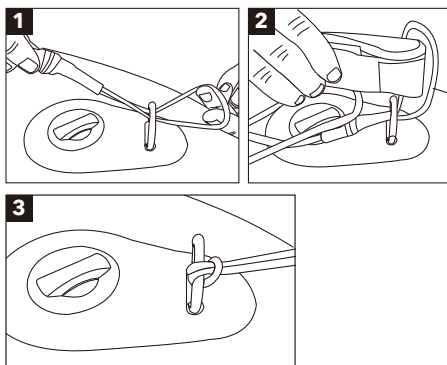

INSTALLATION DE LEASH POUR RIVIÈRE/ SURF/BOBINE

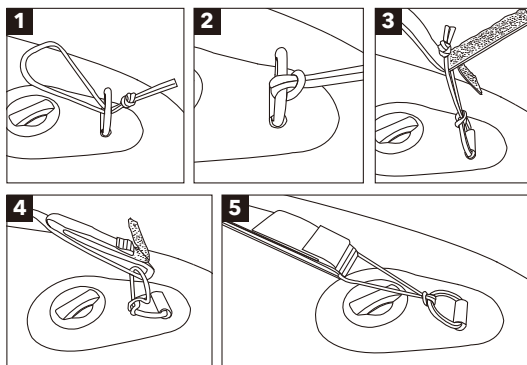

COMMENT ENTREtenir VOTRE SUP

À FAIRE

NETTOYAGE

Nettoyez la planche après chaque utilisation avec de l'eau douce et un savon doux.



GARDEZ-LA AU SEC

Faites sécher la planche après chaque utilisation, et surtout avant de la ranger pour éviter les dommages causés par la moisissure.



USAGE FRÉQUENT

Utilisez la planche fréquemment car un stockage prolongé peut entraîner une détérioration de l'adhésif.



ENTRETIEN RÉGULIER

Vérifiez régulièrement qu'il n'y a pas de fissures, d'éraflures ou tout autre problème et réparez si nécessaire.



Ne pas faire

NE PAS UTILISER DE COMPRESSEUR D'AIR

Vous pouvez facilement surgonfler la planche en utilisant un compresseur d'air et l'endommager.



NE PAS TRAÎNER

Ne pas traîner la planche car des débris tranchants pourraient la perforer.



ÉVITER TOUTE EXPOSITION DIRECTE AU SOLEIL

Gardez la planche à l'ombre lorsqu'elle n'est pas utilisée avec une pression de service inférieure à 50%-60% de la pression d'air max.



ÉVITER LES TEMPÉRATIONS EXTREMES

Conservez les planches à l'abri des températures extrêmes et de l'humidité. Gardez-les à température ambiante entre 0°C - 40°C.



FAQs (Foire aux questions)

Q: Quelle pression d'air dois-je pomper dans ma planche, et combien de temps faut-il pour la gonfler ?

A: La pression maximale est de 15 à 18 PSI (8 PSI pour MEGA, 10 PSI pour la chambre intérieure HYPER, 3 PSI pour les chambres latérales DRIFT), toute pression supérieure risque de causer un sur-gonflage et des dommages. En fonction de la taille de votre planche, cela peut prendre entre 5 et 8 minutes.

Q: Lorsque l'on détache la pompe du tableau, l'air commence à s'échapper de la valve. Comment puis-je empêcher ce phénomène ?

A: La sortie d'air est due au fait que la tige du ressort de la valve est restée en position de dégonflage. Il suffit de la pousser vers le bas et de tourner la goupille jusqu'à ce qu'elle se soulève en position de gonflage et empêche l'air de s'échapper ; continuez à gonfler la planche jusqu'à ce qu'elle soit à la pression voulue.

COMMENT RÉPARER UNE COUPURE OU UN TROU SUR VOTRE PLANCHE GONFLABLE

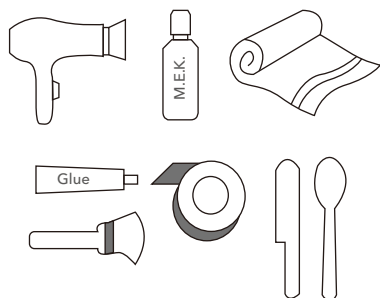

MATERIEL NECESSAIRE

- Colle (AQUASEAL® est recommandée)
- Acétone ou méthyléthylcétone (M.E.K.)
- Sèche-cheveux
- Brosse
- Ruban
- Spatule ou cuillère
- Serviette (N'est pas fournie avec le Produit)



1

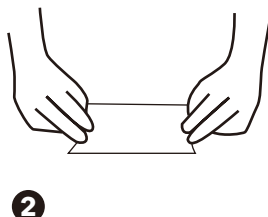

2

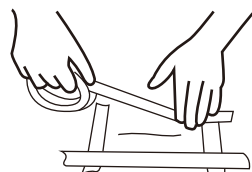

3

1. Nettoyez la zone autour de la coupure ou de la ponction en utilisant de l'acétone ou M.E.K
2. Dessinez le contour du patch à l'aide de craie ou d'un crayon (n'utilisez pas d'encre). Coupez le patch, couvrir la coupure ou le trou avec environ 2,5 cm (1 pouce) dépassant de tous les côtés
3. Appliquez du ruban le long du contour du patch. Cela empêchera la colle de se répandre à l'extérieur de la zone du patch.

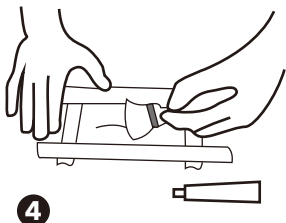

4

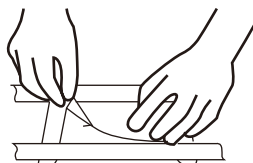

5

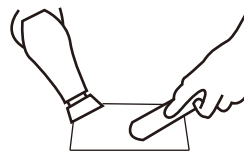

6

4. Appliquez de la colle sur le panneau et le patch en utilisant une brosse ou un autre applicateur. Assurez-vous que la colle est répartie uniformément et complètement sur la planche et le patch. Laissez

sécher la colle pendant 5 minutes.

5. Appliquez le patch en commençant d'un côté et en vous déplaçant vers l'autre côté tout en faisant attention à ne pas laisser des bulles d'air.
6. Utilisez un sèche-cheveux pour chauffer doucement la zone afin d'assurer une bonne liaison entre le patch et la planche. Appuyez fortement à l'aide d'une spatule ou une cuillère pour assurer une bonne adhérence et éliminer les bulles d'air.

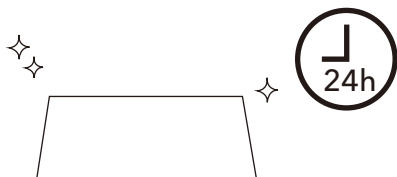

Laisser la colle sécher sur la planche non gonflée pendant 24 heures avant toute utilisation.

COMMENT RÉPARER UNE VALVE QUI FUIT

A. Essayez de serrer la valve

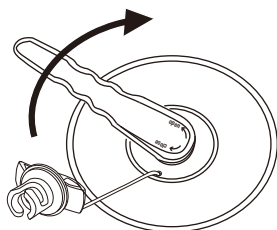

1. Gonflez votre planche jusqu'à la pression maximale
2. Collez votre clé à valve à l'intérieur de la valve en bas et tournez-la dans le sens des aiguilles d'une montre pour resserrer la valve sur la planche.

B. Réinstallez ou remplacez une valve

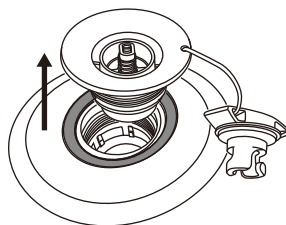
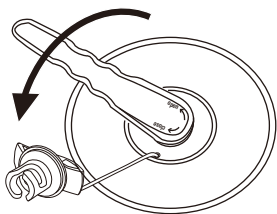

1. Dégonflez complètement votre planche
2. Dévissez le capuchon anti poussière et insérez la clé de à valve dans la valve et tournez-la dans le sens antihoraire pour retirer la valve

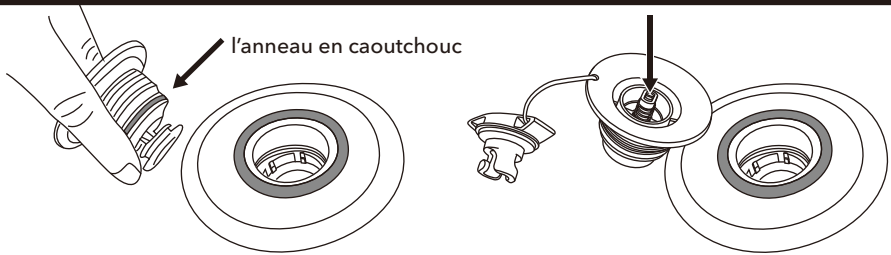

3. Vérifiez l'anneau en caoutchouc pour vous assurer qu'il est dans la bonne position, qu'il est serré autour de la valve et qu'il n'y a pas de débris dessus.
4. Assurez-vous que le ressort à goupille fonctionne correctement et qu'il n'y a pas de fissures sur les bords.

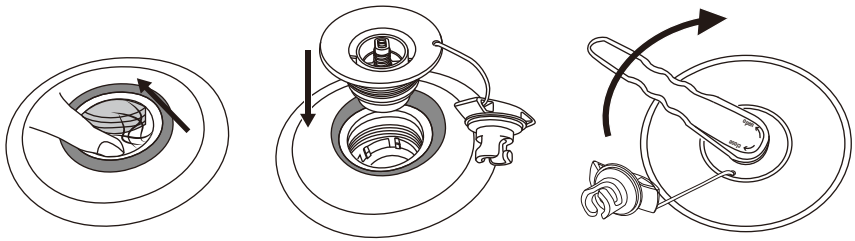

5. Assurez-vous qu'il n'y a pas de ficelles provenant de la couture du tissu.
6. Assurez que la partie inférieure de la valve n'est pas attachée à quelque chose.
7. Remettez la valve dans votre planche.
8. Alignez tous les fils et faites-les tourner pour les serrer.
9. Une fois que la valve est serrée à la main, utilisez la clé à valve pour la fermer à fond.



Utilisez la clé correctement en appuyant dessus avec la main.

GARANTIE

2
AN

AM garantit ce produit contre tout défaut matériel important ou de fabrication à l'acheteur initial pour une période de **2 ans** (planche **UNIQUEMENT**) à compter de la date d'achat. Cette garantie est soumise aux conditions suivantes:

1. La garantie est valide seulement lorsque ce produit est utilisé pour des activités récréatives normales et elle ne couvre pas les produits utilisés en cas de location ou pour un apprentissage.
2. AM pourra fixer une détermination finale de la garantie, ce qui peut nécessiter une inspection et / ou des photos de l'équipement, qui montrent clairement le (s) défaut(s). Si nécessaire, cette information doit être envoyée au distributeur AM de votre pays avec l'affranchissement prépayé. Le produit ne pourra être retourné que si un numéro d'autorisation de retour est donné à l'avance par le distributeur AM. Le numéro d'autorisation de retour doit être clairement indiqué à l'extérieur du colis, sinon le produit sera refusé.
3. Si un produit est jugé défectueux par AM, la garantie couvre uniquement la réparation ou le remplacement du produit défectueux. AM ne sera pas responsable des coûts, pertes ou dommages subis à la suite d'une perte ou d'une mauvaise utilisation de ce produit.
4. Cette garantie ne couvre pas les dommages causés par une mauvaise utilisation, abus, négligence, usure normale y compris, les crevaisons, les dommages dus à une exposition excessive à la chaleur, les dommages causés par une manipulation et un stockage inadéquats, les dommages causés par une utilisation au milieu de vagues ou de rives escarpées, en cas de dégradations de la planche causée par le remplissage ou la dégradation dans des conditions de surf, ou les dommages causés par autre chose que des défauts de matériaux et de fabrication.
5. Le produit ne doit pas être modifié et / ou équipé d'un moteur sauf l'ailette de puissance AM BlueDrive
6. Le produit ne doit pas être utilisé en dépassant la capacité de charge maximale recommandée par le fabricant.
7. Cette garantie est nulle si une réparation, ou modification non autorisée a été faite à n'importe quelle partie de l'équipement.
8. La garantie pour tout équipement réparé ou de remplacement est recevable uniquement à compter de la date de l'achat original.
9. Le reçu d'achat original doit accompagner toutes les demandes de garantie. Le nom du détaillant et la date d'achat doivent être clairs et lisibles.
10. Il n'existe aucune garantie autre que celle spécifiée ici.



ATTENTION

Ce produit est conçu conformément aux normes pour un usage spécifique. Toute modification ou transformation importante autre que celle indiquée par le fabricant peut entraîner des risques sérieux pour l'utilisateur et annule la garantie.

DE



AQUA MARINA

AUFBLASBARES
STAND-UP PADDLE
BEDIENUNGSANLEITUNG



WARNUNG

Zu Ihrer eigenen Sicherheit und der Ihrer Ausrüstung sollten Sie die folgenden Vorsichtsmaßnahmen treffen. Nichtbeachtung von Warnhinweisen und Anweisungen können zu Sachschäden, schweren Verletzungen oder zum Tod führen.

ALLGEMEINE INFORMATIONEN ZUM PADDELN

Diese Anleitung soll Ihnen helfen, Ihr aufblasbares Stand-Up Paddle (nachfolgend ISUP genannt) sicher und mit Freude zu benutzen. Sie enthält Angaben zum ISUP, den gelieferten Geräten und Informationen zu deren Betrieb. Bitte lesen Sie sie sorgfältig durch und machen Sie sich mit dem ISUP vertraut, bevor Sie es benutzen.

SICHERHEIT

Es besteht die Gefahr von schweren Verletzungen oder Tod durch Ertrinken. Paddelsport kann sehr gefährlich und körperlich anstrengend sein. Der Anwender dieses Produktes kennt die Risiken des Paddelsports, er versteht und übernimmt sie. Beachten Sie die folgenden Warnhinweise und Sicherheitsstandards sorgfältig bei jeder Verwendung dieses Produkt Es.



AM Offizielle Website



AM HOW-TO sanleitung



AM Servicecenter-Liste

WARNHINWEISE ANWEISUNG



VERBINDLICHE ANWEISUNG

- Persönliche Schwimmhilfe tragen
- Anleitung zuerst lesen
- Alle Luftkammern komplett aufblasen
- Anzahl der Benutzer
- Max. Tragfähigkeit
- Sicherheitsabstand zum Ufer 150 m (492.1 Fuß)



VERBOTSANWEISUNG

- Nicht in Wildwasser verwenden (außer BT-22RP)
- Nicht in brechenden Wellen verwenden (außer BT-22WA)
- Nicht bei Flachwasserströmung verwenden
- Nicht bei Hochseewind verwenden
- Nicht für Kinder im Alter von 14 Jahren und weniger (außer BT-22VIP)



ACHTUNG / GEFAHR / WARNUNG

- Nennbetriebsdruck
- Kein Schutz gegen Ertrinken



VERBINDLICHE ANWEISUNG

- Nur für Schwimmer

CN-ORP

Item No.:

Oriental Recreational Products (Shanghai) Co., Ltd.
1699 Daye Road, Fengxian Shanghai, China 201402

PRODUKTSERIENNUMMER

- Artikelnummer
- Herstellerdaten

UNIVERSAL

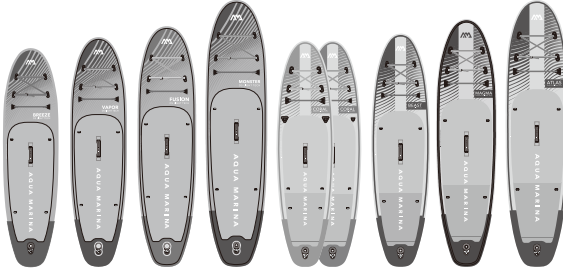

TOURING



RACING

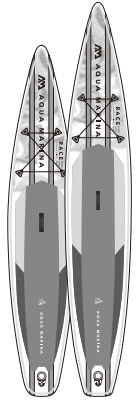

MODELL

BREEZE **VAPOR** **FUSION** **MONSTER**
 BT-23BRP BT-23VAP BT-23FUP BT-23MOP

CORAL **BEAST** **MAGMA** **ATLAS**
 BT-23COPR BT-23BEP BT-23MAP BT-23ATP
 BT-23COPN

CORAL TOURING **HYPER** **HYPER**
 BT-23CTPR BT-23HY01 BT-23HY02
 BT-23CTPN

RACE **RACE**
 BT-21RA01 BT-21RA02

GRÖSSE

9'10" 10'4" 10'10" 12'0"
 30" 31" 32" 33"
 4.7" 6" 6" 6"

10'2" 10'6" 11'2" 12'0"
 31" 32" 33" 34"
 4.7" 6" 6" 6"

11'6" 11'6" 12'6"
 31" 31" 32"
 6" 6" 6"

12'6" 14'0"
 27" 27"
 6" 6"

300 cm 315 cm 330 cm 366 cm
 76 cm 79 cm 81 cm 84 cm
 12 cm 15 cm 15 cm 15 cm

310 cm 320 cm 340 cm 366 cm
 78 cm 81 cm 84 cm 86 cm
 12 cm 15 cm 15 cm 15 cm

350 cm 350 cm 381 cm
 79 cm 79 cm 81 cm
 15 cm 15 cm 15 cm

381 cm 427 cm
 69 cm 69 cm
 15 cm 15 cm

FIN

1 EINSCHUB-MITTELFINNE

1 SCHNELL ZU BEFESTIGENDE MITTELFINNE

1 SCHNELL ZU BEFESTIGENDE RACING-FINNE

1 RENNFLOSSE

VOLUME

229 L 315L 338L 390L

238L 312L 340L 398L

328L 330L 370L

320L 360L

MAX. BENUTZER GEWICHT

220 LBS 308LBS 330LBS 374LBS
 100 KG 140KG 150KG 170KG

231LBS 308LBS 330LBS 396LBS
 105KG 140KG 150KG 180KG

286LBS 330LBS 374LBS
 130KG 150KG 170KG

330LBS 352LBS
 150KG 160KG

MAX. LUFTDRUCK

15 PSI











15 PSI

15 PSI

15 PSI

15 PSI /
 10 PSI
 (mittlere Kammer)

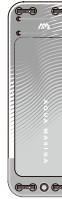
18 PSI

	FLUSS	SURFEN	WINDSURFEN	MEHRPERSONEN				FITNESS		FISCHEN	KIND
											
RACE ELITE BT-22RE	RAPID BT-22RP	WAVE BT-22WA	BLADE BT-22BL	SUPER TRIP BT-21ST01	SUPER TRIP TANDEM BT-20ST02	MEGA BT-20ME	AIRSHIP RACE BT-20AS	DHYANA BT-23DHP	PEACE BT-23PC	DRIFT BT-20DRP	VIBRANT BT-22VIP
14'0" 25" 6"	9'6" 33" 6"	8'8" 30" 4"	10'6" 33" 6"	12'2" 32" 6"	14'0" 34" 6"	18'1" 60" 8"	22'0" 34" 8"	10'8" 34" 6"	8'2" 35" 6"	10'10" 38" 6"	8'0" 28" 4"
427 cm 63.5 cm 15 cm	289 cm 84 cm 15 cm	265 cm 75 cm 10 cm	320 cm 84 cm 15 cm	370 cm 82 cm 15 cm	427 cm 86 cm 15 cm	550 cm 152 cm 20 cm	670 cm 87 cm 20 cm	325 cm 86.5 cm 15 cm	250 cm 90 cm 15 cm	330 cm 97 cm 15 cm	244 cm 71 cm 10 cm
1 RACING-FINNE AUS FIBERGLAS	1 FLUSSFLOSSE + 4 FESTE FLOSSEN	1 AILERON CENTRAL DE SURF + 2 AILERONS LATÉRAUX	1 DOLCHFLOSSE + 1 MITTENFLOSSE	1 MITTENFLOSSE	2 MITTENFLOSSE	5 MITTENFLOSSE	1 RENN-FLOSSE	1 SCHNELL ZU BEFESTIGENDE MITTELFINNE /		1 MITTENFLOSSE	1 MITTENFLOSSE
330L	300L	161L	350L	400L	500L	1400L	1000L	347L	340L	284L	140L
330LBS 150KG	286LBS 130KG	209LBS 95KG	330LBS 150KG	462LBS 210KG	507LBS 230KG	1433LBS 650KG	1014LBS 460KG	341LBS 155KG	330LBS 150KG	286LBS 130KG	132LBS 60KG
18 PSI	18 PSI	18 PSI	18 PSI	15 PSI	18 PSI	8 PSI	18 PSI	15 PSI		15 PSI (Brett) / 3PSI (seitenluftkammern)	15 PSI

Yoga Deck BT-23YD
 Außendurchmesser: 290cm/9'6"
 Innendurchmesser: 170cm/6'7"
 Dicke: 12cm/4.7"



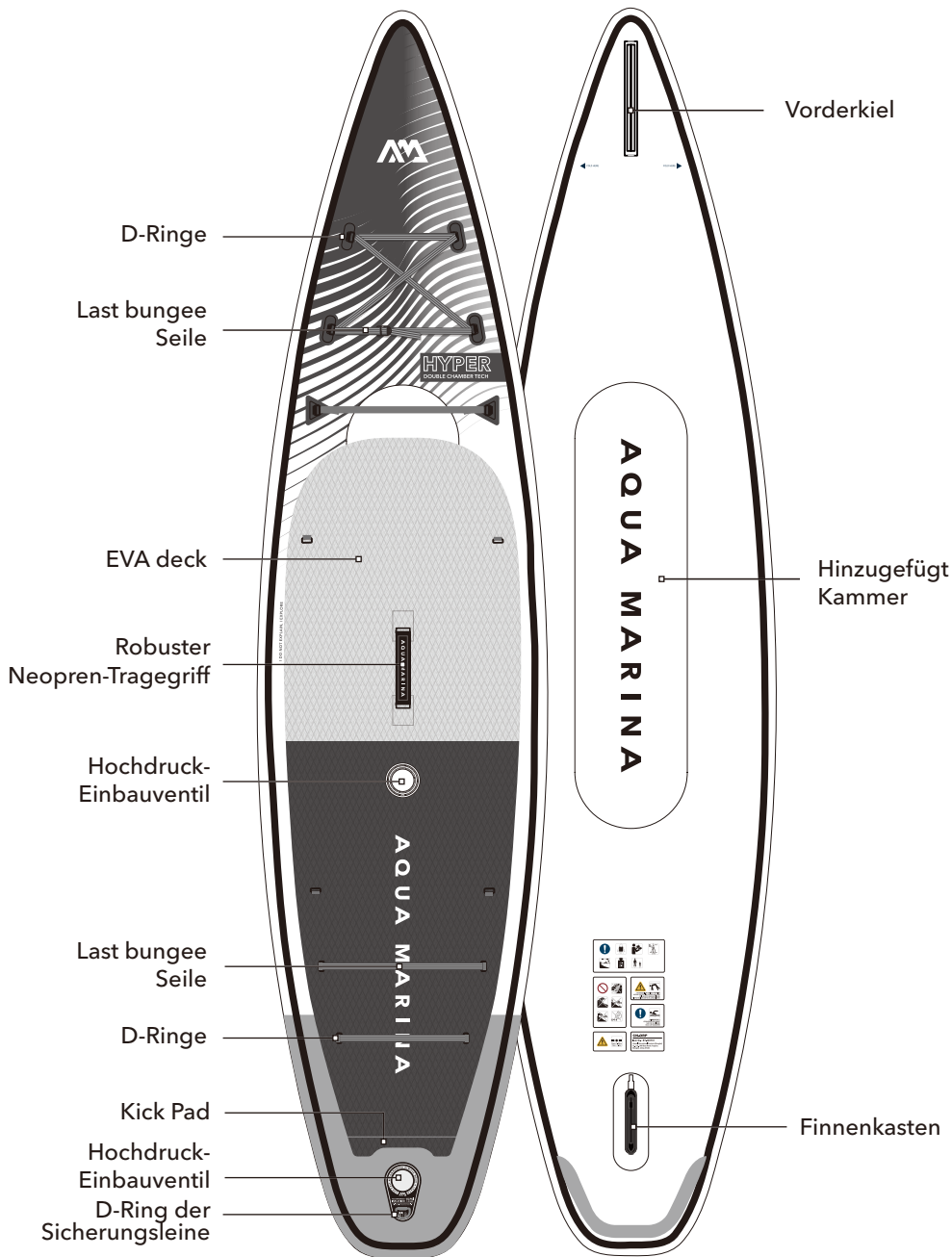

Die tatsächliche Konfiguration kann je nach Modell variieren.

ACCESSORIES

STANDARD

Rucksack mit
Reissverschluss



Doppelaktion Pumpe
(Mega/Airship Race/ Super Trip Tandem x 2)



Mittelfinne
(Mega x 5/
Super Trip Tandem x 2/
Wave x 3/ Blade x 2)



Last Bungee Seile
(außer Wave)



Leine
(außer Super Trip/ Super Trip Tandem/Mega/
Airship Race/Peace/Yoga Dock)

Reparatursatz



***Die tatsächliche Konfiguration kann je nach Modell variieren.**

DRIFT

Angelstockhalter x 2

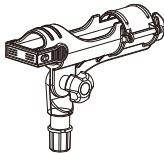

Paddelhalter

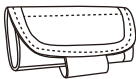

MEGA/YOGA DOCK

Tragtasche



CORAL/CORAL TOURING/YOGA

Brettriemen

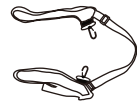

Paddelhalter
(Nur für Dhyana)



Riemen x 3
(Nur für Dhyana)



PADDEL

Paddel (außer Race/Race Elite/Hyper/Rapid/Super Trip/Mega/
Airship Race/Blade/Wave/Peace/Super Trip Tandem)

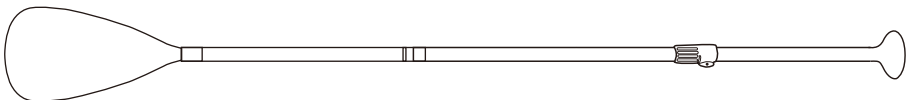

MONTAGE- UND DEMONTAGEANLEITUNG

AUFPUMPEN

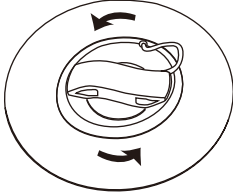

Öffnen Sie die Ventilkappe durch Drehen gegen den Uhrzeigersinn. Stellen Sie sicher, dass das Ventil vor dem Öffnen frei von Schmutz, Sand oder Schmutz ist.

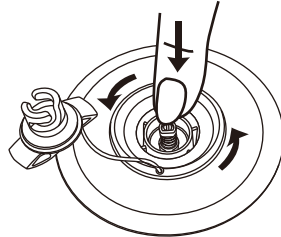

Drücken Sie den Ventilknopf hinein und drehen Sie ihn um 90°.

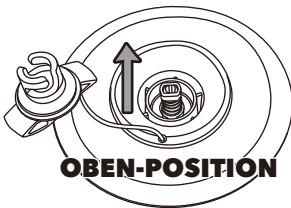

OBEN-Position

Ventiltaste springt für das Aufpumpen in die „OBEN-Position“.

ODER

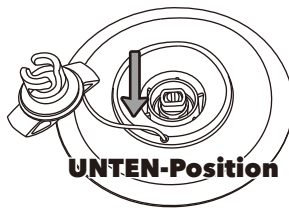

UNTEN-Position

Ventilknopf für das Ablassen in UNTEN-Position arretiert.

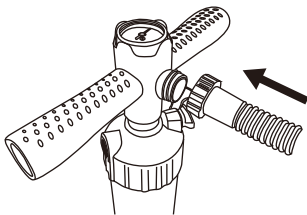

Anbringen - Den Pumpenschlauch an der Pumpe fest anbringen.

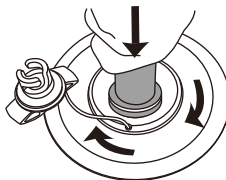

Verbinden - Das Ende des Pumpenschlauchs am Ventil anbringen und um 45° im Uhrzeiger-sinn drehen, um in.Position zu arretieren.

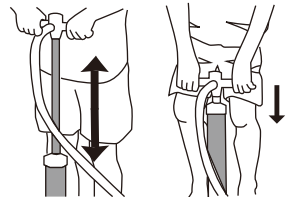

Effizienter Pumpen - Bei steigendem Druck Arme gestreckt und Knie gebeugt halten, um effizienter zu pumpen.

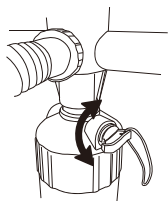

LIQUID AIR V1

Schnelles Aufpumpen -

Verwenden Sie die DOPPELAKTION-Position, indem Sie den Lufthahn schließen, um das Board auf 0,48 bis 0,69 bar (7-10 psi) aufzupumpen.

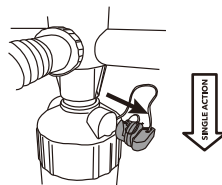
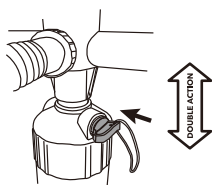

Leichtes Aufpumpen -

Wechseln Sie zur EINZELAKTION-Position, indem Sie den Lufthahn für ein leichteres Aufpumpen entnehmen.

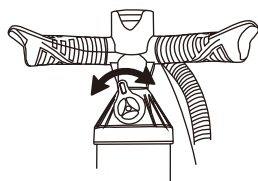

LIQUID AIR V2

Schnelles Aufpumpen -

Verwenden Sie den DOPPELAKTION-Modus, wobei die obere Kappe „2“ anzeigt, um das Board auf 0,48 bis 0,69 bar (7-10 psi) aufzupumpen.

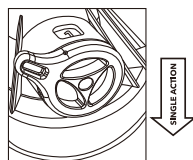
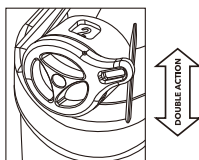

Leichtes Aufpumpen -

Wechseln Sie zum EINZELAKTION-Modus, wobei die obere Kappe für das leichtere Aufpumpen „1“ anzeigt.

Hinweis: Das Messgerät wird nicht reagieren, bis es 0,28 bar (4 psi) erreicht. Einfach 2-3 Minuten Luft einpumpen!

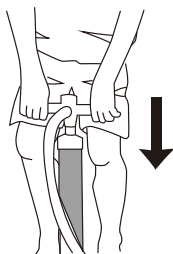

Max. Druck -
Pumpen Sie das Board auf bis zu 1,03-1,24 bar/15-18 psi auf.



Mindestens 0,83 BAR/12 PSI (0,55 BAR/8 PSI für MEGA / 0,69 BAR/10 PSI für Innenkammer von HYPER) für den ordnungsgemäßen Betrieb von aufblaßbaren Boards und maximal 1,03 BAR/15 PSI (1,24 BAR/18 PSI für SUPER TRIP TANDEM/ RAPID/ RACE/ RACE ELITE/ WAVE/ BLADE/ AIRSHIP RACE). Übermäßiges Aufpumpen führt zum Erlöschen der Garantie.

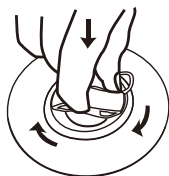

Nach dem Aufpumpen, setzen Sie die Ventilkappe wieder auf und ziehen sie im Uhrzeigersinn fest, bis sie in Position einrastet.

Warnhinweis:

Lassen Sie Ihr Board nicht an Orten mit direkter Sonneneinstrahlung liegen, da dies zu einem Überdruck führen kann.

Bitte halten Sie das auf Nennluftdruck aufgepumpte Board bei Nichtgebrauch im Schatten. NICHT ÜBER 0,69 bar/10 psi aufpumpen, oder belassen Sie Ihr Board an einem kühlen, trockenen Ort. Denken Sie daran, den Luftdruck vor und nach dem Gebrauch zu überprüfen und lassen Sie bei Bedarf die Luft Ihres Boards ab.

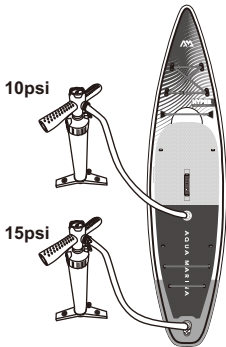

Für Doppelkammer-Brett

Für die beste Leistung sollte die Doppelkammer immer aufgeblasen werden, um höchste Steifigkeit und Sicherheit zu gewährleisten.

- Füllen Sie die innere Kammer bis zu 10 PSI auf.
- Füllen Sie dann die äußere Kammer bis zu 15 PSI auf.

VORSICHT UND TIPPS

- Elektrische Pumpen können verwendet werden, um das Brett bis zu 80-90% aufzublasen. Der erforderliche Restdruck sollte jedoch mit der Handpumpe erreicht werden, um ein Überfüllen zu vermeiden.
- Verwenden Sie keine Druckluftkompressoren, da dadurch die Garantie für das Brett erlischt.
- Stellen Sie vor langen Fahrten sicher, dass das Brett aufgeblasen ist und mindestens 24 Stunden lang Druck aufrechterhalten hat.

MONTAGE DER FINNE

System für Einschub-Mittelfinne

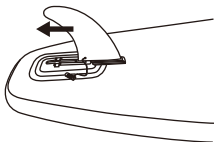

EINSCHIEBEN -
Schieben Sie die große.

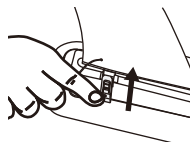

EINSETZEN -
Setzen.

Schnell zu befestigendes Finnensystem

(CORAL / BEAST / MAGMA / ATLAS / CORAL TOURING / HYPER / WAVE / DHYANA)

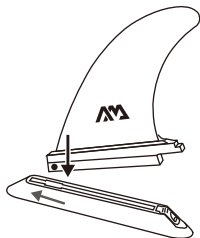

EINSTECKEN - Richten Sie den Finnenbasis am Schlitz des Finnenkastens aus und schieben Sie diesen an die Vorderkante.

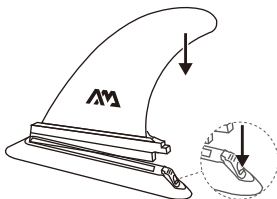

DRÜCKEN - Halten Sie weiter die Taste an der Rückseite gedrückt und drücken Sie die Flosse nach unten.

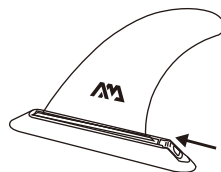

EINSCHNAPPEN - Verriegeln Sie die Finne, indem Sie in Position einschnappt.

HINWEIS: Installieren Sie die Seitenfinnen von WAVE, wie unten dargestellt.

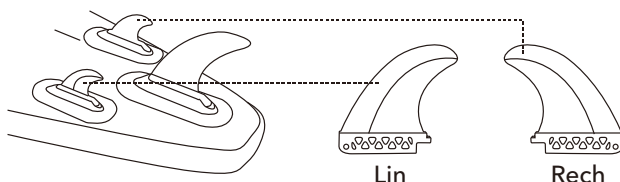

US-Finnen-System (RACE ELITE)

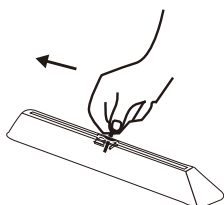

UNTERLEGSSCHEIBE - Legen Sie die Unterlegscheibe in den Finnenkasten und schieben Sie sie nach vorne.

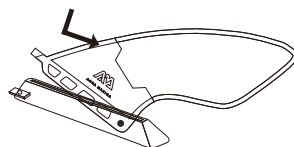

EINSTECKEN - Richten Sie die Finnenbasis am Finnenschlitz aus und schieben Sie diesen nach hinten an den Finnenkasten.

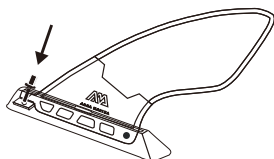

AUSRICHTEN - Schieben Sie die Finne nach unten und richten Sie die Unterlegscheibenöffnung auf die Schraube aus.

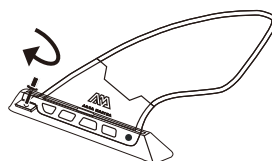

SCHRAUBE - Durch Anschrauben fest anbringen.

Luftablassen

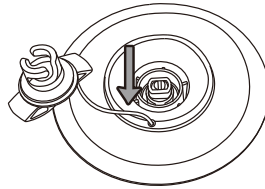
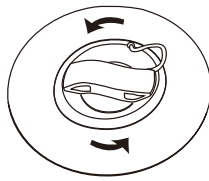

Ventil öffnen - Öffnen Sie die Ventilkappe und drehen Sie den Ventilknopf in die „UNTEN-POSITION“. Stellen Sie sicher, dass das Ventil vor dem Öffnen frei von Schmutz, Sand oder Schmutz ist.



Luftablassen (von Hand) - Rollen Sie das Board von der Nase bis zum Tail, um die Luft herauszudrücken.

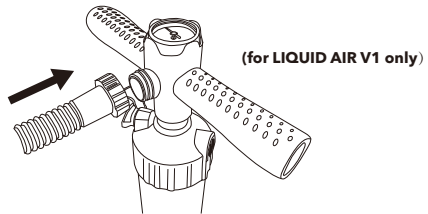

Luftablassen (mit der Pumpe) - Verwenden Sie die Pumpe in der Position „LUFTABLASSEN“.

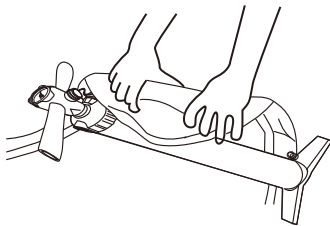

Rollen - Rollen Sie das Board um die Pumpe. Stellen Sie sicher, dass sich die Pumpe in der Mitte befindet.

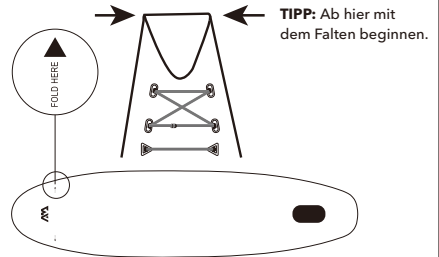

ODER

Rollen - Der Faltnie für den anfänglichen Faltvorgang folgen und dann das Board von der Nase bis zum Tail aufrollen.

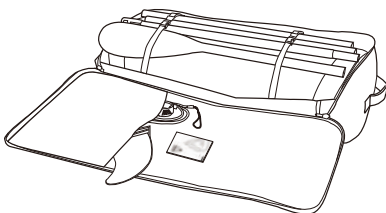

Packen - Verwenden Sie das Gurtband, um das ordentlich aufgerollte Board in Position zu halten, ziehen Sie den Gurt jedoch nicht zu fest an. Legen Sie das Zubehör in die Tasche.

ANWEISUNGEN FÜR DAS YOGA DOCK

Verbindung von YOGA DOCK und DHYANA

Jedes DHYANA Yoga Board kann mit diesem YOGA DOCK anhand von drei Gurten verbunden werden.

Befolgen Sie für jeden Gurt die unten dargestellten Verbindungsanweisungen.

1. Verbinden Sie den Karabiner (a) am D-Ring (b) des Boards. Fädeln Sie den Gurt durch den D-Ring (c) des Docks.
2. Fädeln Sie den Gurt durch die Schnalle (d) und ziehen Sie ihn an.
3. Wiederholen Sie die obigen Schritte für die restlichen Gurte.

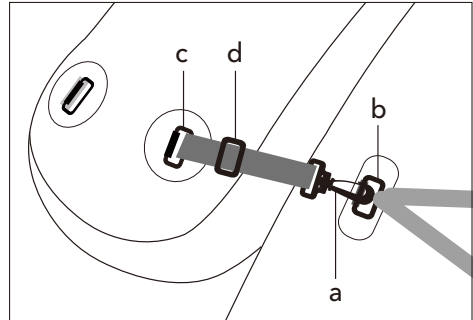

Faltvorgang und Lagerung

1. Falten Sie das Yoga Dock wie unten dargestellt.
2. Verstauen Sie das Yoga Dock in der Tragetasche.

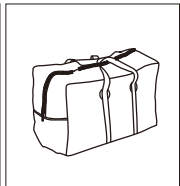
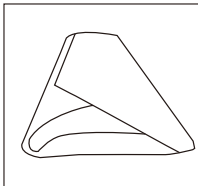
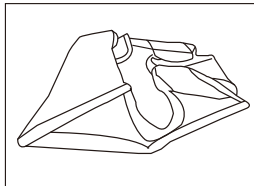
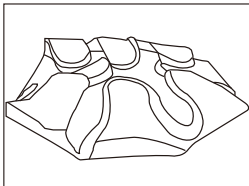

PADDEL ZUSAMMENBAU

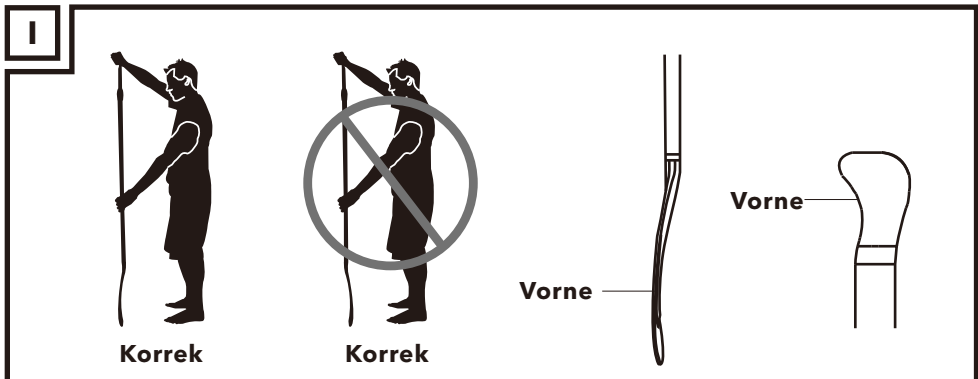

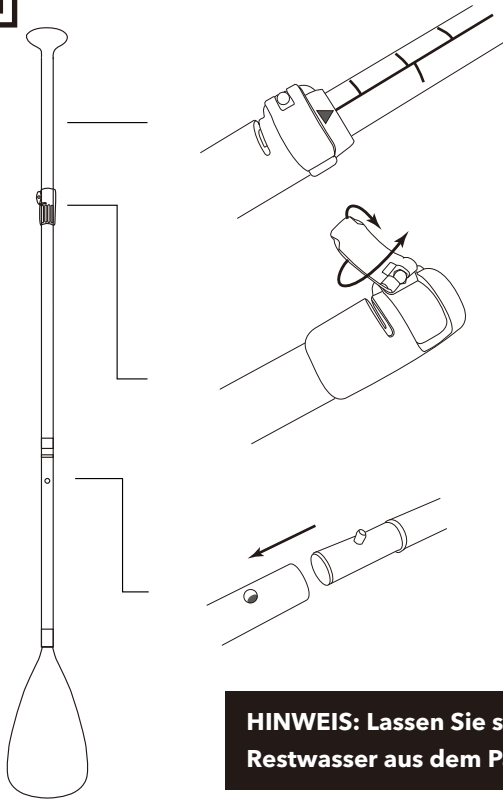

Stellen Sie sicher, dass die Mittellinie mit der Anzeige auf der Klemme ausgerichtet ist.

KLEMMSYSTEM FÜR
Einstellung des Festsitzes durch Drehen der Haspel, um jegliches Spiel zu vermeiden.

EIN SICHERES FEDERSTIFTSYSTEM
Sicheres Federstift.

HINWEIS: Lassen Sie stets nach der Verwendung das Restwasser aus dem Paddelrohr ab.

3 PCS ADJUSTABLE

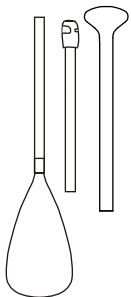

- **ACE** B0303622
Einstellbares Aluminium iSUP-Paddel für Kinder
- **SPORTS III** B0303922
Anpassbares Aluminium iSUP Paddel
- **PASTEL** B0303923/24/25
Fiberglass / iSUP-Paddel aus Karbon
- **SOLID** B0303013
Anpassbares Fiberglas iSUP Paddel
- **CARBON GUIDE** B0303014
Kohle- / Glasfaser iSUP Paddel
- **CARBON PRO** B0303015
Kohle iSUP Paddel

2 PCS ADJUSTABLE

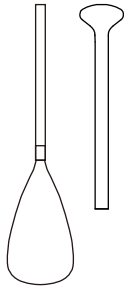

- **CARBON X**
B0303016
2-teiliges iSUP-Paddel aus Karbon

2-IN-1

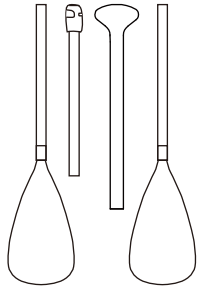

- **DUAL-TECH**
B0303011
2-in-1 iSUP & Kayak Paddel

WIE MAN EINEN SICHERHEITSLAISEN TRAGT

TAILLE



FLUSS-LEASH
(SICHERUNGSLAINE)
B0303025

KNÖCHEL



SPIRALFÖRMIGE
LEASH
(SICHERUNGSLAINE)
B0303930



SURFBOARD
LEASH
(SICHERUNGSLAINE)
B0303024



STANDARD-LEASH
(SICHERUNGSLAINE)
B0303929

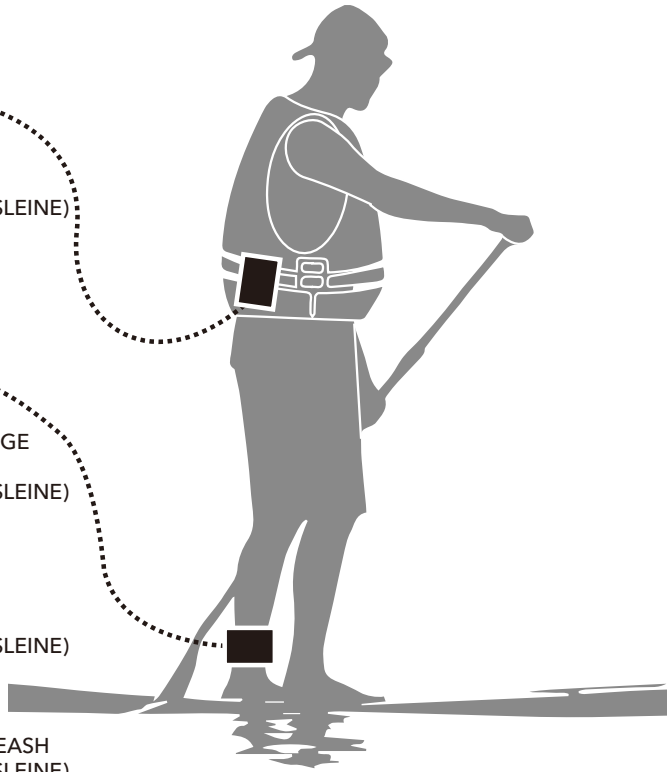

MONTAGE DER STANDARD-LEASH (SICHERUNGSLAINE)

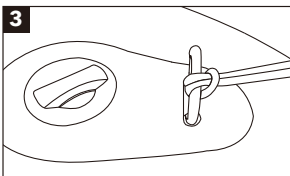
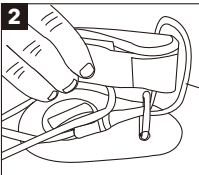
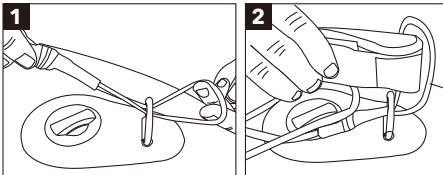

MONTAGE DER SPIRALFÖRMIGEN/ SURFBOARD/FLUSS-LEASH (SICHERUNGSLAINE)

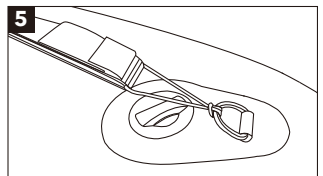
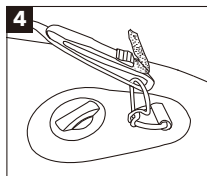
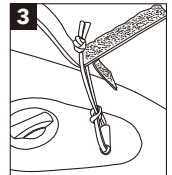
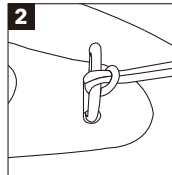
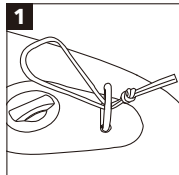

ZUR HANDHABUNG DES ISUP-BOARDS

DO'S

REINIGUNG

Reinigen Sie das Board nach jedem Gebrauch mit Süßwasser und milder Seife.



TROCKENHALTEN

Trocknen Sie das Board nach jedem Gebrauch ab, insbesondere vor der Lagerung, um Schäden durch Schimmelbildung zu vermeiden.



HÄUFIGER GEBRAUCH

Benutzen Sie das Board regelmäßig, da eine lange Lagerdauer zur Detorierung des Klebers führen kann.



REGELMÄSSIGE WARTUNG

Regelmäßig auf Risse, Kratzer oder andere Probleme prüfen und ggf. reparieren.



DON'TS

VERWENDEN SIE KEINEN LUFTKOMPRESSOR

Durch die Verwendung eines Luftkompressors kann das Board leicht Überdruck ausgesetzt werden, woraufhin der Garantieanspruch verfällt.



NICHT ZIEHEN

Ziehen Sie das Board nicht am Boden entlang, da scharfe Fremdkörper es durchstoßen könnten.



DIREKTE SONNENEINSTRALHUNG VERMEIDEN

Legen Sie das Board bei Nichtgebrauch in den Schatten mit einem Betriebsdruck von weniger als 50-60 % des max. Luftdrucks.



EXTREME TEMPERATUREN MEIDEN

Bewahren Sie die Boards vor extremen Temperaturen und Feuchtigkeit geschützt auf. Bei Raumtemperatur zwischen 0-40 °C lagern.



FAQs (häufig gestellte Fragen)

Q: Wie viel Luft sollte ich in mein Brett pumpen und wie lange dauert das Aufblasen?

A: Der maximale Druck beträgt 1,03-1,24 BAR/15-18 PSI (0,55 BAR/8 PSI für MEGA, 0,69 BAR/10 PSI für Innenkammer von HYPER, 0,21 BAR/3 PSI für die Seitenkammern für DRIFT), bei höherem Druck besteht die Gefahr von Überdruck und Beschädigung. Abhängig von der Größe Ihres Boards kann dies zwischen 5 und 8 Minuten dauern.

Q: Beim Abtrennen der Pumpe beginnt die Luft aus dem Ventil zu entweichen. Wie kann das vermieden werden?

A: Die Luft entweicht, da der Ventilsfederstift offen ist. Drücken Sie den Stift einfach nach unten und drehen Sie ihn, bis er sich in die Aufblasposition hebt und die Luft nicht mehr entweichen kann. Pumpen Sie das Brett weiter auf, bis der Druck erreicht ist.

HWIE MAN EINEN SCHNITT ODER EIN LOCH IM AUFBLASBAREN BRETT REPARIERT

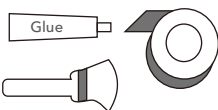

MATERIALIEN

- Klebe (AQUASEAL® Ist empfohlen)
- Aceton oder Methylethylketon (M.E.K.)
- Haartrockner
- Bürste
- Band
- Spatel oder Löffel
- Handtuch
(Nicht im SUP-Board Satz enthalten)

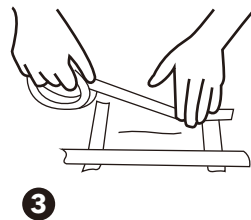
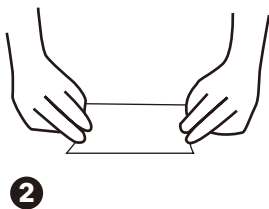

1. Reinigen Sie den Bereich um den Schnitt oder den Einstich mit Aceton oder M.E.K.
2. Zeichnen Sie den Umriss des Flickens mit Kreide oder Bleistift (keine Tinte verwenden). Schneiden Sie das Pflaster ab, bedecken Sie den Schnitt oder die Pktion mit ca. 2,5 cm (1 Zoll) Überlappung auf allen Seiten.
3. Klebeband entlang der Kontur des Pflasters anbringen. Dadurch wird verhindert, dass sich der Kleber außerhalb des Flickensbereichs ausbreitet.

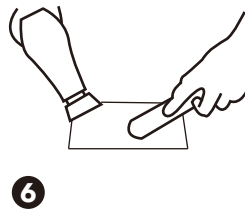
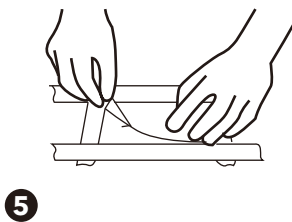
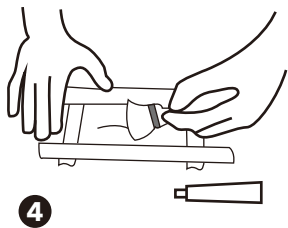

4. Kleber mit einem Pinsel oder einem anderen Applikator auf das Brett und das Pflaster auftragen. Vergewissern Sie sich, dass der Kleber gleichmäßig und vollständig über das Brett und den Flickens verteilt ist.

Lassen Sie den Kleber 5 Minuten trocknen.

5. Tragen Sie das Pflaster von einer Seite auf die andere Seite auf und achten Sie darauf, keine Luftblasen einzufangen.
6. Verwenden Sie einen Haartrockner, um den Bereich sanft zu erwärmen, um eine gute Verbindung zwischen dem Patch und dem Board zu gewährleisten. Verwenden Sie einen Metallspachtel oder -löffel und festen Druck, um eine gute Haftung zu gewährleisten und eventuelle Luftblasen zu entfernen.

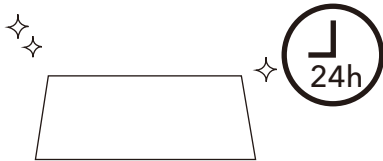

Lassen Sie den Kleber 24 Stunden vor dem Gebrauch ohne Aufblasen aushärten.

BEHEBEN EINES UNDICHTEN VENTILS

A. Versuchen Sie, das Ventil festzuziehen

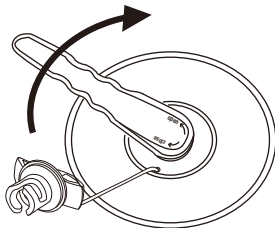

1. Pumpen Sie Ihr Brett bis zum maximalen Luftdruck auf
2. Stecken Sie Ihren Ventilschlüssel in das Ventil und drehen Sie ihn im Uhrzeigersinn, um das Ventil wieder auf dem Brett festzuziehen

B. Montage oder Ersatz eines Ventils

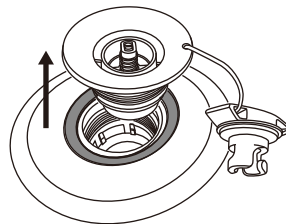
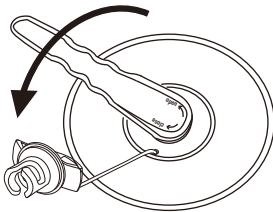

1. Entleeren Sie Ihr Brett vollständig
2. Öffnen Sie die Staubkappe, stecken Sie den Ventilschlüssel in das Ventil und drehen Sie ihn gegen den Uhrzeigersinn, um das Ventil zu entfernen

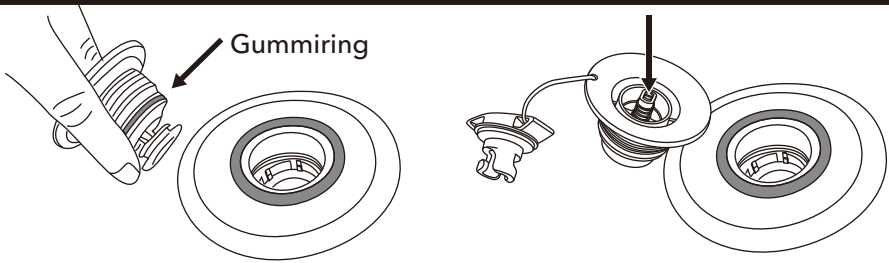

3. Überprüfen Sie den Gummiring, um sicherzustellen, dass er sich in der richtigen Position befindet, dicht um das Ventil liegt und sich dort keine Rückstände befinden
4. Stellen Sie sicher, dass die Stiffeder ordnungsgemäß funktioniert und dass keine Risse an den Kanten vorhanden sind

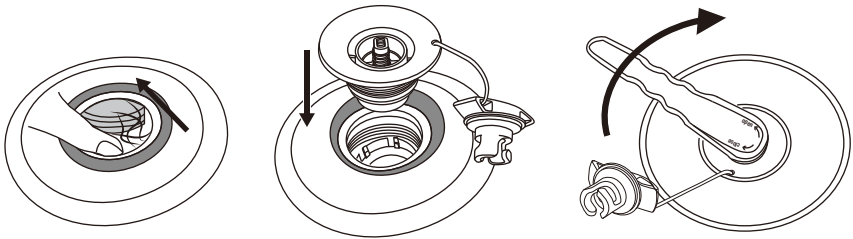

5. Vergewissern Sie sich, dass das Fallstichmaterial keine Fäden enthält
6. Beachten Sie, dass das untere Teil des Ventils an nichts befestigt ist
7. Bauen Sie das Ventil wieder in Ihr Brett ein
8. Richten Sie alle Gewinde aus und drehen Sie sie zum Festziehen
9. Sobald das Ventil handfest angezogen ist, verwenden Sie den Ventilschlüssel, um es vollständig abzudichten



HINWEIS: Verwenden Sie den Schraubenschlüssel richtig, indem Sie ihn mit einer Hand oben drauf drücken.

GARANTIE

**2
JAHR**

AM gewährleistet dem Erstkäufer für einen Zeitraum von **2 Jahren** (NUR das Board) ab dem Kaufdatum, dass dieses Produkt frei von größeren Material- oder Verarbeitungsfehlern ist. Diese Garantie unterliegt folgenden Einschränkungen

1. Die Garantie ist nur gültig, wenn dieses Produkt für normale Freizeitaktivitäten verwendet wird und nicht für Produkte, die im Verleih oder Schulbetrieb verwendet werden.
2. AM wird die endgültige Garantiebestimmung vornehmen, die eine Inspektion und/oder Fotos des Geräts erfordern kann, die den/die Defekt(e) deutlich zeigen. Falls erforderlich, müssen diese Informationen an den AM-Händler in Ihrem Land mit frankiertem Porto geschickt werden. Das Produkt kann nur zurückgegeben werden, wenn der AM-Händler im Voraus eine Rückgabeberechtigungsnummer angegeben hat. Die Rücksendenummer muss auf der Außenseite des Pakets deutlich gekennzeichnet sein, sonst wird sie abgelehnt.
3. Wenn ein Produkt von AM als fehlerhaft eingestuft wird, deckt die Garantie nur die Reparatur oder den Ersatz des fehlerhaften Produkts ab. AM ist nicht verantwortlich für Kosten, Verluste oder Schäden, die durch Verlust oder Missbrauch dieses Produkts entstehen.
4. Diese Garantie erstreckt sich nicht auf Schäden, die durch Missbrauch, Misshandlung, Vernachlässigung, normalen Verschleiß, einschließlich, aber nicht beschränkt auf Einstiche, Schäden durch übermäßige Hitzeeinwirkung, Schäden durch unsachgemäße Handhabung und Lagerung, Schäden, die verursacht werden durch Einsatz bei Wellen oder Küstenbrechern, Brettbruch durch Auffüllen oder Absturz unter Surfbedingungen oder Schäden, die nicht durch Material- und Verarbeitungsfehler verursacht wurden.
5. Dieses Produkt darf nicht verändert und/oder mit einem Motor außer einer AM BlueDrive Power-Finne ausgestattet werden.
6. Dieses Produkt darf nicht über die vom Hersteller empfohlene maximale Tragfähigkeit hinaus verwendet werden.
7. Diese Garantie erlischt, wenn eine nicht autorisierte Reparatur, Änderung oder Modifikation an irgendeinem Teil der Ausrüstung vorgenommen wurde.
8. Die Garantie für alle reparierten oder ausgetauschten Geräte gilt ab dem Datum des nur Originalkauf.
9. Der Original-Kaufbeleg muss allen Garantieansprüchen beiliegen. Der Name des Händler und Kaufdatum müssen deutlich und lesbar sein.
10. Es gibt keine Garantien, die über die hier angegebene Garantie hinausgehen.



WARNUNG

Dieses Produkt ist normgerecht für einen bestimmten Einsatzzweck ausgelegt. Änderungen oder Umbauten, die über die vom Hersteller angegebenen Werte hinausgehen, können zu ernsthaften Risiken für den Benutzer führen und führen zum Erlöschen der Garantie.

ES



AQUA MARINA

INFLABLE
STANDUP PADDLE BOARD
Manual de Usuario



ADVERTENCIA

Para su propia seguridad y la de su equipo, siga las siguientes precauciones. No seguir los avisos de seguridad e instrucciones puede resultar en daños a la propiedad, lesiones graves o la muerte

INFORMACIÓN GENERAL DE REMADO

Este manual ha sido compilado para ayudarle a operar su tabla inflable de Surf de Remo (en lo sucesivo ISUP) con seguridad y placer. Contiene detalles de la PU-RDSI, los equipos suministrados e información sobre su funcionamiento. Léalo detenidamente y familiarícese con la PU-RDSI antes de usarlo.

SEGURIDAD

Existe el riesgo de lesiones graves o la muerte por ahogamiento. Los deportes de remo pueden ser muy peligrosos y físicamente exigentes. El usuario de este producto reconoce, entiende y asume los riesgos involucrados en los deportes de remo. Siga las siguientes etiquetas de advertencia y estándares de seguridad cuidadosamente cuando usa este producto.



AM Official Site



AM HOW-TO Guide



AM Service Center List

INSTRUCCIONES DE ETIQUETA DE ADVERTENCIA



INSTRUCCIONES OBLIGATORIAS

- Use un dispositivo de flotación personal
- Lea primero las instrucciones
- Infle completamente todas las cámaras de aire
- Número de usuarios
- Max. capacidad de carga
- Distancia segura a la orilla 150 m (492.1')



INSTRUCCIONES DE PROHIBICIÓN

- No lo use en aguas blancas (excepto BT-20RP)
- No usar en olas rompientes (excepto BT-20WA)
- No lo use en corrientes en alta mar
- No usar en viento de alta mar
- No apto para niños de 14 años o menores (excepto BT-19VIP)



ATENCIÓN / PELIGRO / ADVERTENCIA

- Diseño presión de trabajo
- Sin protección contra ahogamiento



INSTRUCCIONES OBLIGATORIAS

- Sólo nadadores

CN-ORP

Item No.:

Oriental Recreational Products (Shanghai) Co., Ltd.
1699 Daye Road, Fengxian Shanghai, China 201402

NÚMERO DE SERIE DEL PROD

- No. Artículo
- Información del fabricante

ALREDEDOR

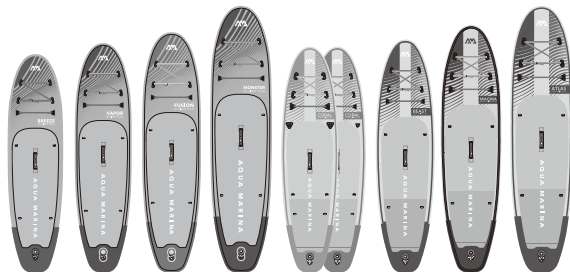

DE PASEO



DE CARRERA

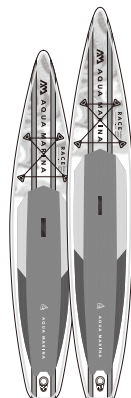

MODELO

BREEZE	VAPOR	FUSION	MONSTER	CORAL	BEAST	MAGMA	ATLAS	CORAL TOURING	HYPER	HYPER	RACE	RACE
BT-23BRP	BT-23VAP	BT-23FUP	BT-23MOP	BT-23COPR BT-23COPN	BT-23BEP	BT-23MAP	BT-23ATP	BT-23CTPR BT-23CTPN	BT-23HY01	BT-23HY02	BT-21RA01	BT-21RA02

TALLA

9'10"	10'4"	10'10"	12'0"	10'2"	10'6"	11'2"	12'0"	11'6"	11'6"	12'6"	12'6"	14'0"
30"	31"	32"	33"	31"	32"	33"	34"	31"	31"	32"	27"	27"
4.7"	6"	6"	6"	4.7"	6"	6"	6"	6"	6"	6"	6"	6"
300 cm	315 cm	330 cm	366 cm	310 cm	320 cm	340 cm	366 cm	350 cm	350 cm	381 cm	381 cm	427 cm
76 cm	79 cm	81 cm	84 cm	78 cm	81 cm	84 cm	86 cm	79 cm	79 cm	81 cm	69 cm	69 cm
12 cm	15 cm	15 cm	15 cm	12 cm	15 cm	15 cm	15 cm	15 cm	15 cm	15 cm	15 cm	15 cm

ALETA

1 ALETA DESLIZABLE CENTRAL

1 ALETA CENTRAL DE MONTAJE RÁPIDO

1 ALETA DE CARRERA DE MONTAJE RÁPIDO

1 ALETA DE CARRERA

VOLUMEN

229 L	315 L	338 L	390 L	238 L	312 L	340 L	398 L	328 L	330 L	370 L	320 L	360 L
-------	-------	-------	-------	-------	-------	-------	-------	-------	-------	-------	-------	-------

PESO MÁXIMO DEL RIDER

220 LBS	308 LBS	330 LBS	374 LBS	231 LBS	308 LBS	330 LBS	396 LBS	286 LBS	330 LBS	374 LBS	330 LBS	352 LBS
100 KG	140 KG	150 KG	170 KG	105 KG	140 KG	150 KG	180 KG	130 KG	150 KG	170 KG	150 KG	160 KG

PRESIÓN MÁXIMA DE AIRE

15 PSI









15 PSI

15 PSI

15 PSI

15 PSI /
10 PSI
(cámara central)

18 PSI

	DE RÍO	SURF	WINDSURF	MULTIPERSONA				APTITUD FÍSICA		PESCA	NIÑOS
								<p>Yoga Dock BT-23YD Outer Diameter: 290cm/9'6" Inner Diameter: 170cm/67" Thickness: 12cm/4.7"</p>  			
RACE ELITE BT-22RE	RAPID BT-22RP	WAVE BT-22WA	BLADE BT-22BL	SUPER TRIP BT-21ST01	SUPER TRIP TANDEM BT-20ST02	MEGA BT-20ME	AIRSHIP RACE BT-20AS	DHYANA BT-23DHP	PEACE BT-23PC	DRIFT BT-20DRP	VIBRANT BT-22VIP
14'0" 25" 6"	9'6" 33" 6"	8'8" 30" 4"	10'6" 33" 6"	12'2" 32" 6"	14'0" 34" 6"	18'1" 60" 8"	22'0" 34" 8"	10'8" 34" 6"	8'2" 35" 6"	10'10" 38" 6"	8'0" 28" 4"
427 cm 63.5 cm 15 cm	289 cm 84 cm 15 cm	265 cm 75 cm 10 cm	320 cm 84 cm 15 cm	370 cm 82 cm 15 cm	427 cm 86 cm 15 cm	550 cm 152 cm 20 cm	670 cm 87 cm 20 cm	325 cm 86.5 cm 15 cm	250 cm 90 cm 15 cm	330 cm 97 cm 15 cm	244 cm 71 cm 10 cm
1 QUILLA DE FIBRA DE VIDRIO	1 ALETA DE RÍO + 4 ALETAS FIJAS	1 QUILLA CENTRAL + 2 QUILLAS LATERALES	1 ALETA TIPO DAGA + 1 ALETA CENTRAL	1 ALETA CENTRAL	2 ALETAS CENTRAL	5 ALETAS CENTRAL	1 ALETA DE CARRERA	1 ALETA CENTRAL DE MONTAJE / RÁPIDO		1 ALETA CENTRAL	1 ALETA CENTRAL
330L	300L	161L	350L	400L	500L	1400L	1000L	347L	340L	284L	140L
330LBS 150KG	286LBS 130KG	209LBS 95KG	330LBS 150KG	462LBS 210KG	507LBS 230KG	1433LBS 650KG	1014LBS 460KG	341LBS 155KG	330LBS 150KG	286LBS 130KG	132LBS 60KG
18 PSI	18 PSI	18 PSI	18 PSI	15 PSI	18 PSI	8 PSI	18 PSI	15 PSI		15 PSI (tabla) / 3PSI (cámaras laterales de aire)	15 PSI

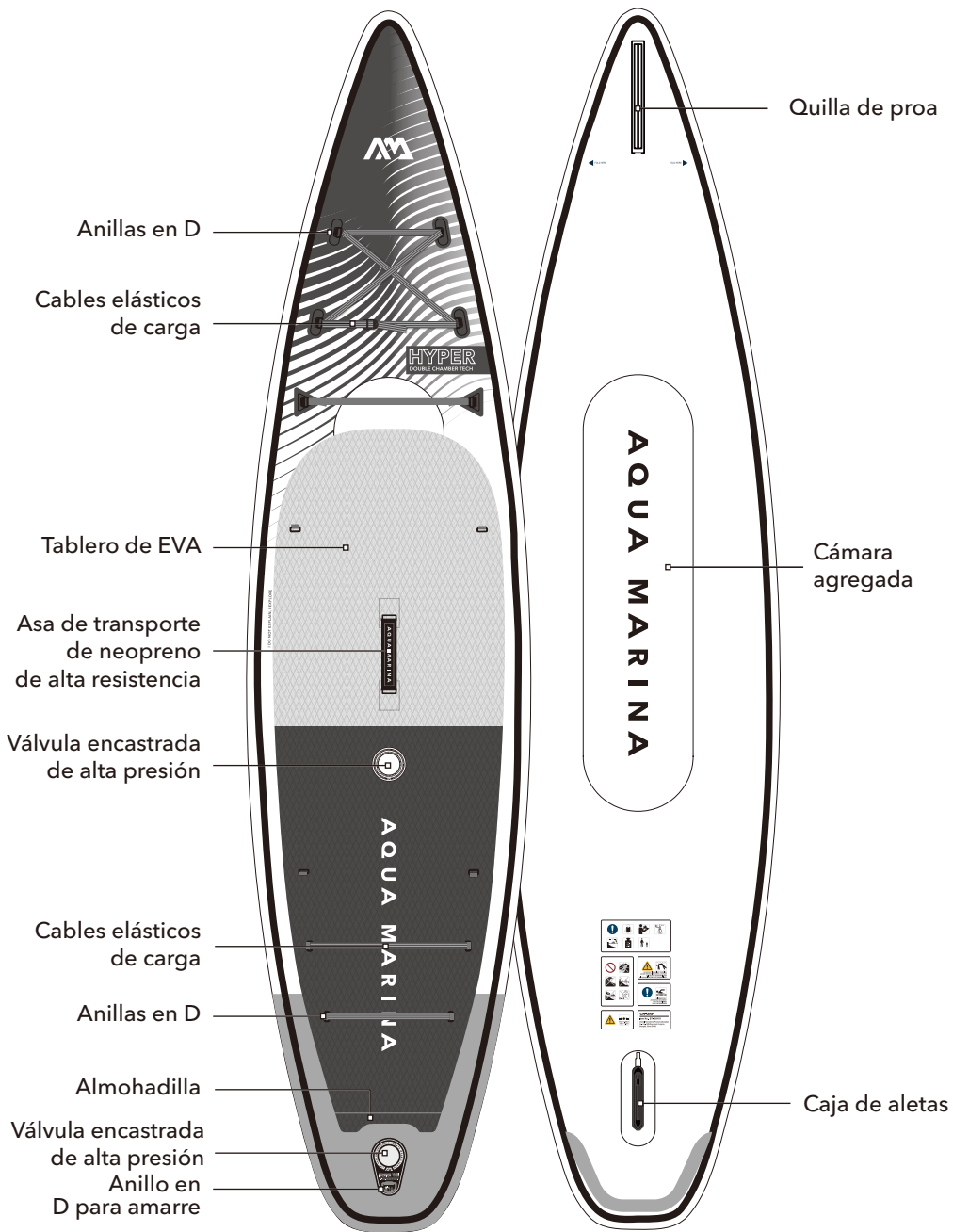

La configuración real puede variar según los modelos.

ACCESSORIES

STANDARD

Mochila de cierre



Bomba de doble acción
(Mega/Airship Race/ Super Trip Tandem x 2)

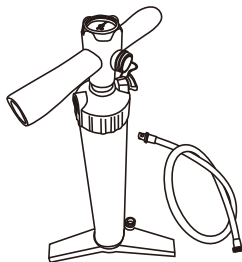

Aleta central

(Mega x 5/
Super Trip Tandem x 2/
Wave x 3/ Blade x 2)



Cables elásticos de carga

(excepto Wave)



Correa

(excepto Super Trip/ Super Trip Tandem/Mega/
Airship Race/Peace/Yoga Dock)

Kit de reparación



***La configuración real puede variar según los modelos.**

DRIFT

Soporte caña de pescar
x 2

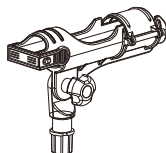

Soporte de remo

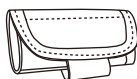

MEGA/YOGA DOCK

Bolsa de transporte



CORAL/CORAL TOURING/YOGA

Tira de tabla



Soporte de remo
(Solo para Dhyana)

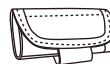

Tiras x 3
(Solo para Dhyana)

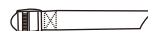

PALETA

PALETA (excepto Race/Hyper/Rapid/Super Trip/Mega/Airship Race/Blade/
Wave/Peace/Super Trip Tandem)

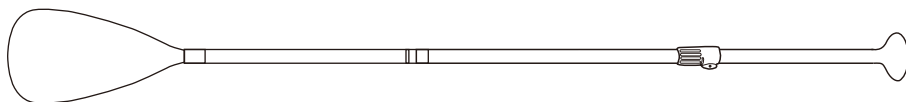

INSTRUCCIONES DE ARMADO Y DESARMADO

INFLADO

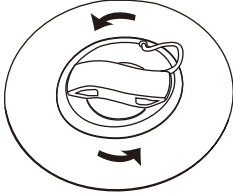

Abra la tapa de la válvula girando en el sentido de las agujas del reloj y asegúrese que la válvula esté libre de residuos, arena o sucio antes de soltarla.

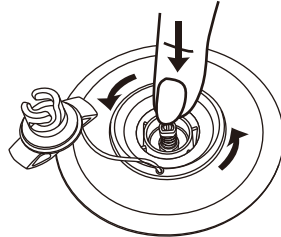

Presione el botón de la válvula y gire 90 grados.



POSICIÓN ARRIBA

El botón de la válvula que sube a "POSICIÓN ARRIBA" para inflar.



POSICIÓN ABAJO

El Botón de la válvula bloqueado en "POSICIÓN ABAJO" para desinflar.

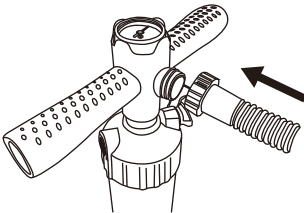

Acoplar - Conecte la manguera de la bomba la misma y fíjela Firmemente.

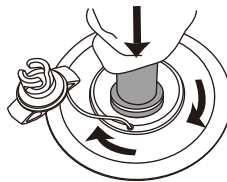

Conectar - Conecte el extremo de la manguera de la bomba a la válvula y gire 45° en el sentido de las agujas del reloj para fijarla en su sitio.

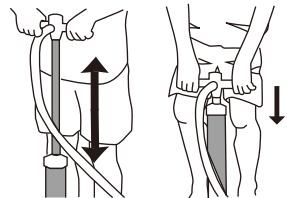

Ahorre esfuerzo - A medida que aumenta la presión, mantenga los brazos extendidos y doble las rodillas para realizar un menor esfuerzo.

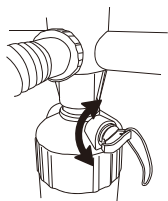

LIQUID AIR V1

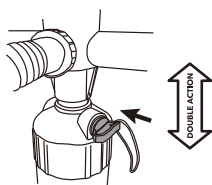

INFLADO RÁPIDO - Utilice la posición "DOBLE ACCIÓN" cerrando así el grifo de aire para bombear la tabla hasta 7-10 psi.

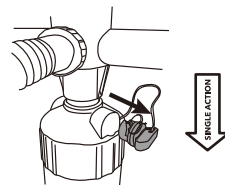

INFLADO FÁCIL - Cambie a la posición de "ACCIÓN ÚNICA" retirando el grifo de aire para facilitar el inflado.

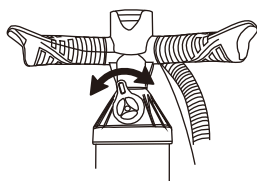

LIQUID AIR V2

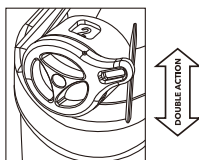

Inflado Rápido - Utilice el modo DOBLE ACCIÓN con la tapa superior mostrando "2" para bombear la tabla hasta 7 - 10 psi.

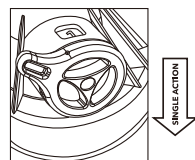

Inflado fácil - Gire el interruptor al modo ACCIÓN SIMPLE con la tapa superior mostrando "1" para un inflado más fácil.

Nota: El medidor no responderá hasta alcanzar 4 psi. Siga bombeando durante 2-3 minutos.

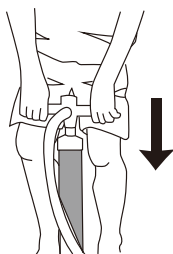

Max. Presión - Siga bombeando la tabla hasta alcanzar 15-18 psi.



12PSI mínimo (8PSI para MEGA / 10PSI para la cámara interior HYPER) para inflado adecuado de tablas y 15PSI máximo de operación (18PSI para SUPER TRIP TANDEM / RAPID / RACE / RACE ELITE / WAVE / BLADE / AIRSHIP RACE). Inflar demasiado anula su garantía.

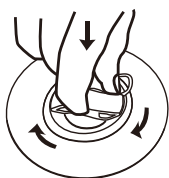

Tras el inflado, vuelva a colocar la tapa de la válvula y apriétela en el sentido de las agujas del reloj para fijarla en su sitio.

Advertencia:

No deje la tabla bajo la luz directa del sol, ya que puede provocar un sobre inflado.

Por favor, mantenga la tabla a la sombra cuando no la utilice con una presión de uso de **NO MÁS DE 10psi**, o deje su tabla en un lugar fresco y seco. Recuerde comprobar la presión del aire antes y después de su uso, y desinfe la tabla cuando sea necesario.

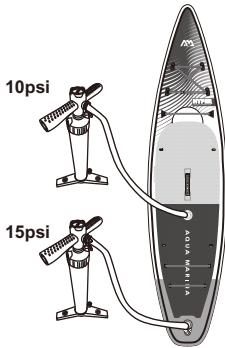

Para tabla de doble cámara (HYPER)

Para obtener el mejor rendimiento, la cámara doble siempre debe estar inflada para garantizar la mayor rigidez y seguridad.

- Infle la cámara interior hasta 10 PSI.
- Infle la cámara exterior hasta 15 PSI.

Precaución y Consejo

- Las bombas eléctricas se pueden usar para inflar la tabla hasta un 80-90%. sin embargo, la presión remanente requerida debe lograrse usando la bomba de mano para evitar el inflado excesivo.
- No use compresores de aire ya que esto anula la garantía de la tabla.
- Antes de realizar viajes largos, asegúrese de que la tabla se haya inflado y haya mantenido la presión durante un mínimo de 24 horas.

INSTALACIÓN DE LAS QUILLAS

Sistema de quilla central deslizante

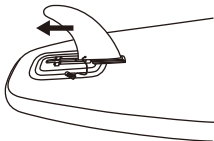

Deslizamiento -
Deslice la quilla central grande a la base de la quilla.

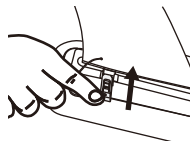

INSERTAR - Insertar La clavija.

Sistema de aleta de montaje rápido

(CORAL / BEAST / MAGMA / ATLAS / CORAL TOURING / HYPER / WAVE / DHYANA)

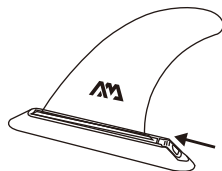
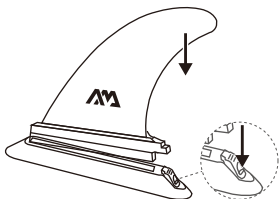
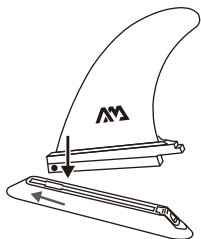

INSERTAR - Alinear la base de la quilla en la ranura de la caja de la quilla y deslizar hacia el borde delantero.

PRESIONAR - Mantenga pulsado el botón de la parte trasera y empuje la quilla hacia abajo.

AJUSTE - Asegure la quilla en su lugar cuando haga el chasquido.

NOTA: Instale las quillas laterales de WAVE como se sugiere a continuación.

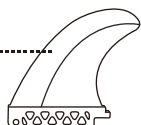
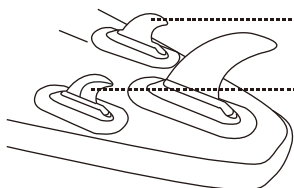

Left

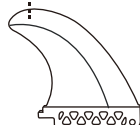

Right

Sistema de quilla US (RACE ELITE)

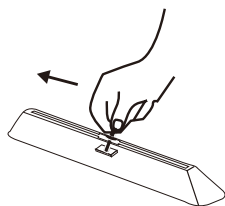

JUNTA - Coloque la junta en la caja de quillas y deslícela hacia el frente.

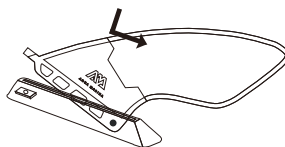

INSERTE - Alinee la base de la quilla en la ranura y deslice hacia la parte posterior de la caja de la quilla.

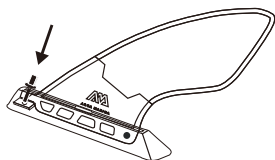

ALINEADO - Empuje la quilla hacia abajo y alinee el agujero de la junta con el tornillo.

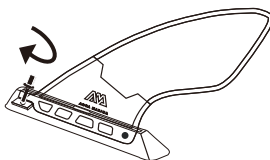

TORNILLO - Asegure firmemente al atornillar.

DESINFLAR

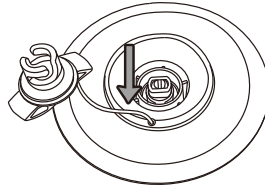
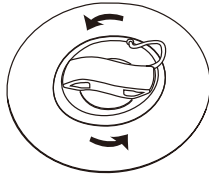

Válvula abierta - Abra la tapa de la válvula y gire el botón de la válvula para la "POSICIÓN DE ABAJO". Asegúrese de que la válvula esté libre de residuos, arena o suciedad antes de soltarla.



Desinflado (con las manos) - Haga rodar la tabla de la punta a la parte posterior para exprimir el aire.

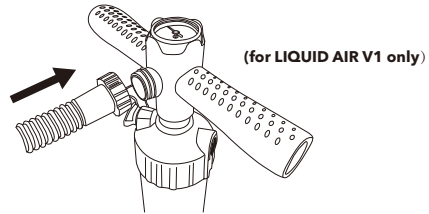

Desinflar (con la bomba) - Utilice la bomba en la posición "DEFLATE".

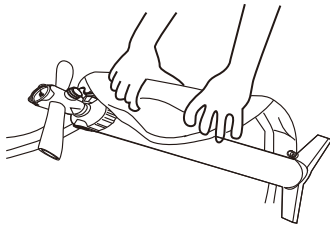

Enrollar - Enrolle la tabla alrededor de la bomba. Asegúrese de que la bomba está asentada en el centro.

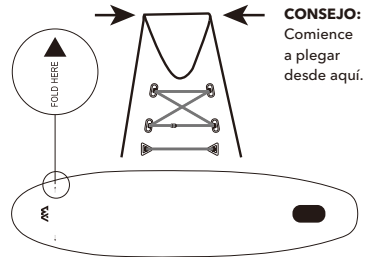

Enrollar - siga la línea indicada para el primer pliegue y enrolle la tabla de punta a cola.

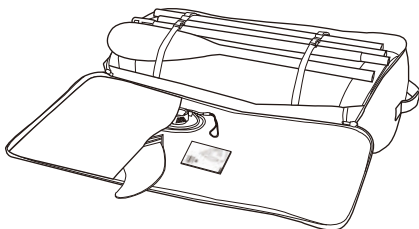

Empaque - Use la correa de red para asegurar la tabla enrollada en su lugar, pero no apriete demasiado la correa. Coloque los accesorios en el bolsillo.

INSTRUCCIONES DE YOGA DOCK

Conexión de YOGA DOCK y DHYANA

Puede conectar cada una de las tablas de yoga DHYANA a este YOGA DOCK mediante tres correas.

Con cada correa, siga las instrucciones de conexión que siguen.

1. Amarre el gancho (a) con el anillo en D (b) de la tabla. Pase la correa a través del anillo en D (c) del Dock.
2. Pase la correa a través de la hebilla (d) y afirme.
3. Repita los pasos anteriores con el resto de las correas.

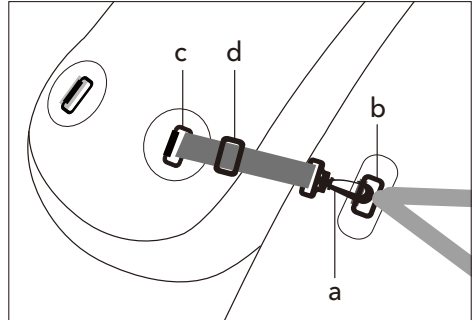

Plegado y almacenamiento

1. Pliegue el Yoga Dock según se muestra a continuación.
2. Guarde el Yoga Dock en la bolsa correspondiente.

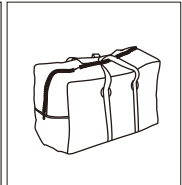
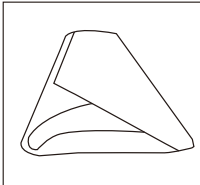
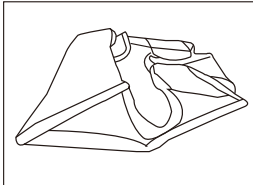
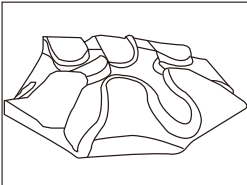

MONTAJE DE LA TABLA

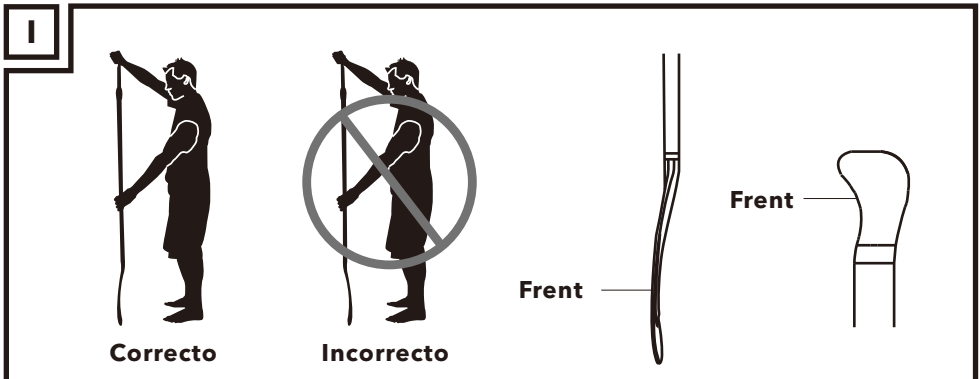

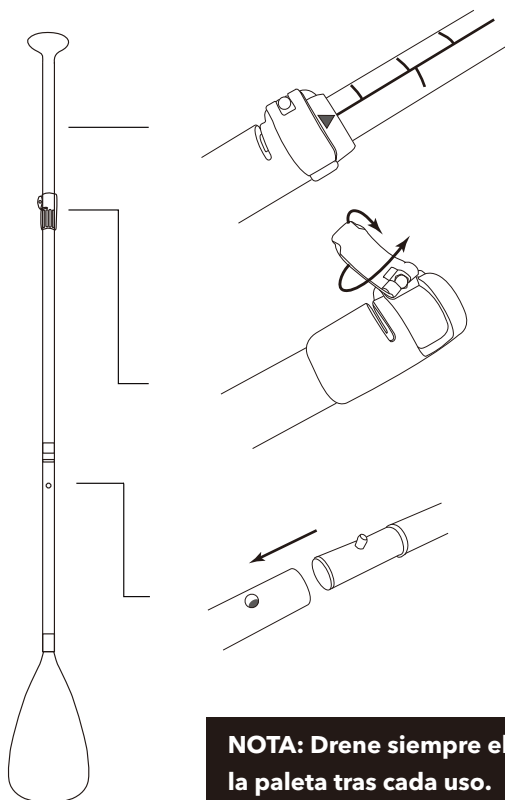

Asegúrese de que la línea central de la escala esté alineada con el indicador de la abrazadera.

SISTEMA DE ABRAZADERA

Ajuste la firmeza girando el pasador para reducir al mínimo posible cualquier juego.

SISTEMA DE PERNO CON MUELLE

Pasador de seguridad.

NOTA: Drene siempre el agua que quede en el eje de la paleta tras cada uso.

3 UDS AJUSTABLES

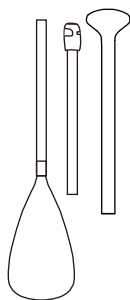

- **ACE** B0303622
Adjustable Aluminum iSUP Paddle for Kids
- **SPORTS III** B0303922
iSUP Tabla ajustable de aluminio
- **PASTEL** B0303923/24/25
Paleta de iSUP de carbono / Fibra de vidrio
- **SOLID** B0303013
Tabla ajustable de Fibra iSUP
- **CARBON GUIDE** B0303014
Tabla carbono/fibra de vidrio
- **CARBON PRO** B0303015
Tabla iSUP de carbono

2 UDS AJUSTABLES

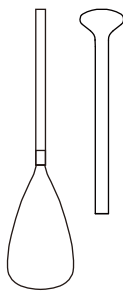

- **CARBON X**
B0303016
Pala de dos secciones de Carbono iSUP

2-IN-1

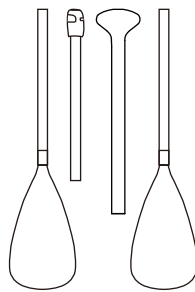

- **DUAL-TECH**
B0303011
2-en-1 iSUP y Tabla de Kayak

CÓMO LLEVAR UNA CORREA DE SEGURIDAD

CINTURA



CORREA FLUVIAL
B0303025

TOBILLO



CORREA DE ROLLO
B0303930



CORREA SE SURF
B0303024



CORREA ESTÁNDAR
B0303929

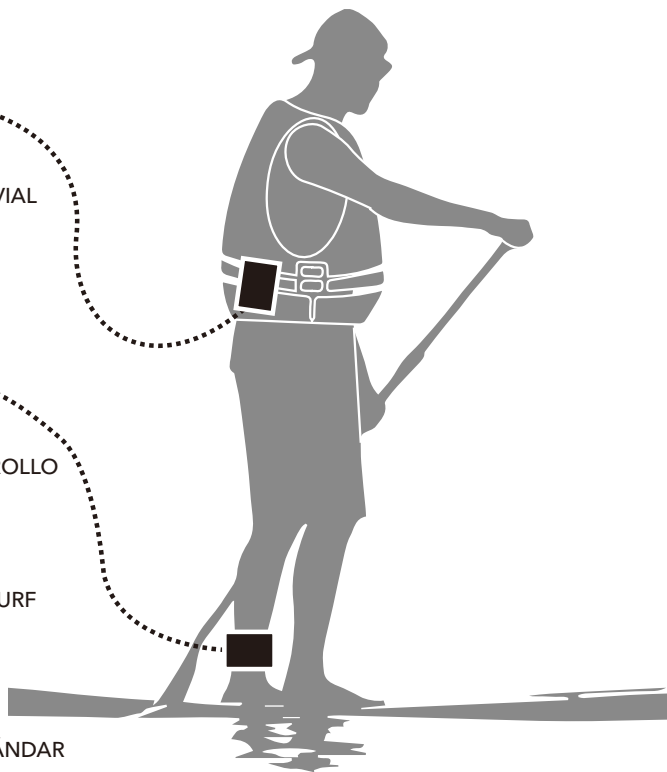

INSTALACIÓN DE CORREA ESTÁNDAR

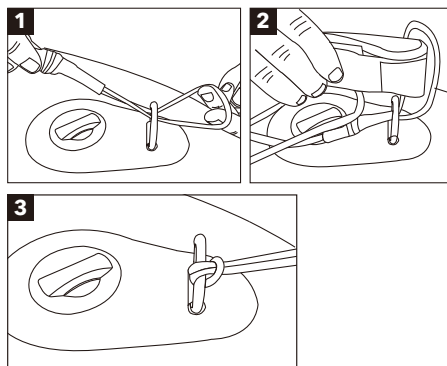

INSTALACIÓN DE CORREA DE ROLLO/ SURF/FLUVIAL

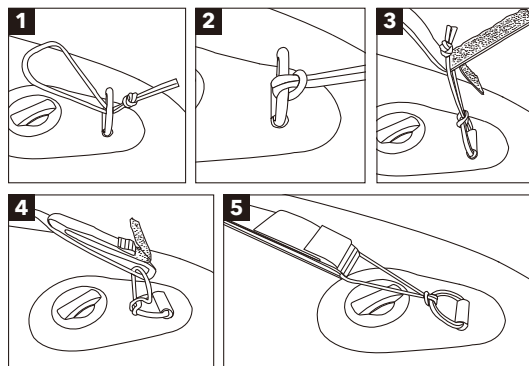

CÓMO CUIDAR LA TABLA ISUP

SI

LIMPIEZA

Limpie la tabla después de cada uso con agua dulce y jabón suave.



MANTENERLA SECA

Seque la tabla después de cada uso, especialmente antes de guardarla para evitar que se dañe con el moho.



USO FRECUENTE

Utilice la tabla con frecuencia, ya que un almacenamiento prolongado puede provocar fallos en el adhesivo.



MANTENIMIENTO REGULAR

Compruebe regularmente si hay grietas, raspaduras o cualquier otro problema y repárelo si es necesario.



NO

NO USE UN COMPRESOR DE AIRE

Podría inflar demasiado la tabla con un compresor de aire y anular la garantía.



NO ARRASTRAR

No arrastre la tabla, ya que fragmentos afilados pueden pincharlo.



EVITAR LA LUZ SOLAR

Mantenga la tabla a la sombra cuando no la utilice con una presión de uso inferior a 50%-60% de la presión de aire máxima.



EVITAR LA TEMPERATURAS EXTREMAS

Mantener las tablas protegidas de las temperaturas extremas y de la humedad. Almacenar a temperatura ambiente entre 0 C - 40 C.



Preguntas frecuentes

Q: ¿Cuánto aire debo bombear en mi tabla y cuánto tiempo tarda en inflarse?

A: La presión máxima es de 15 a 18 PSI (8 PSI para MEGA, 10 PSI para la cámara interior HYPER, 3 PSI para las cámaras laterales DRIFT), si es más alta se corre el riesgo de sobreinflarse y dañarse. Dependiendo del tamaño de su tabla puede tardar entre 5 y 8 minutos.

Q: Al separar la bomba de la tabla, el aire empieza a salir de la válvula. ¿Cómo puedo evitar que esto ocurra?

A: El aire se está liberando porque el pasador del muelle de la válvula se ha quedado en la posición de desinflado. Simplemente empuje hacia abajo y gire el pasador hasta que se levante a la posición de inflado y deje de liberar aire; continúe inflando la tabla hasta alcanzar.

CÓMO REPARAR UN CORTE O PERFORACIÓN EN LA TABLA

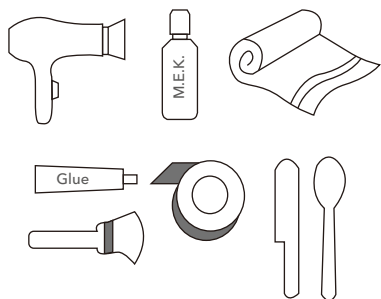

Suministros Requeridos

- Pegamento (AQUASEAL® recomendado)
 - Acetona o metiletilcetona
 - Secador de pelo
 - Cepillo
 - Cinta
 - Espátula o cuchara
 - Toalla
- (No se proporciona en el paquete de la placa SUP)

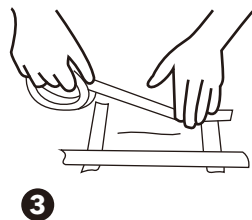
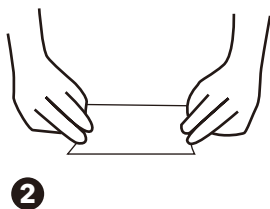

1. Limpie el área alrededor del corte o pinche con acetona o M.E.K
2. Dibuje el contorno del parche con tiza o lápiz (no use tinta). Corte el parche, cubra el corte o pinche con una superposición de aproximadamente 2,5 cm (1 pulgada) en todos los lados.
3. Coloque cinta a lo largo del contorno del parche. Esto evitará que el pegamento se extienda fuera del área del parche.

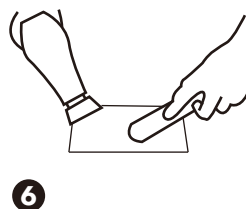
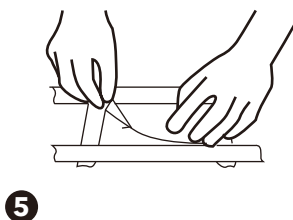
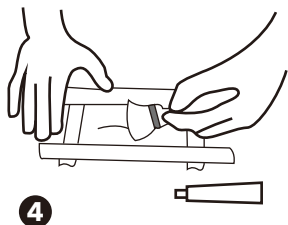

4. Aplique pegamento tanto en la pizarra como en el parche con un cepillo u otro aplicador. Asegúrese de que el pegamento se extienda uniforme y completamente sobre la tabla y el parche. Deje que el pegamento se seque durante 5 minutos.

- Coloque el parche empezando por un lado y moviéndose hacia el otro lado teniendo cuidado de no atrapar burbujas de aire.
- Use un secador de pelo para calentar suavemente el área para asegurar una buena unión entre el parche y la tabla. Use una espátula o cuchara de metal y presione firmemente para asegurar una buena unión y para eliminar cualquier burbuja de aire.

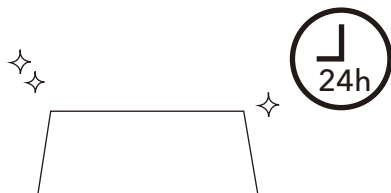

Deje que el pegamento se seque con la placa sin inflar durante 24 horas antes de su uso.

CÓMO ARREGLAR UNA VÁLVULA CON FUGA

A. Apriete la válvula

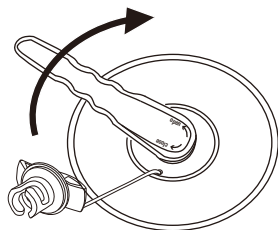

- Infle la tabla hasta la presión máxima de aire
- Apriete la llave de la válvula dentro de la válvula y gire a la derecha para apretar la válvula dentro de la tabla

B. Reinstale o reemplace la válvula

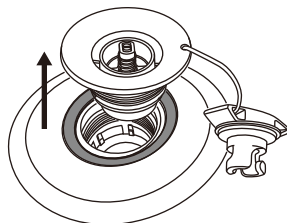
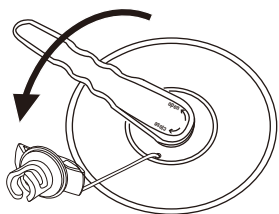

- Desinfe completamente su tabla
- Quite el tapón de polvo e inserte la llave de la válvula dentro de la válvula y gire a la izquierda para retirar la válvula.



3. Compruebe el anillo de goma para asegurarse de que está en la posición correcta, apriete alrededor de la válvula y asegúrese de que no haya residuos en medio
4. Asegúrese de que el pasador elástico funciona correctamente y que no haya grietas por los bordes

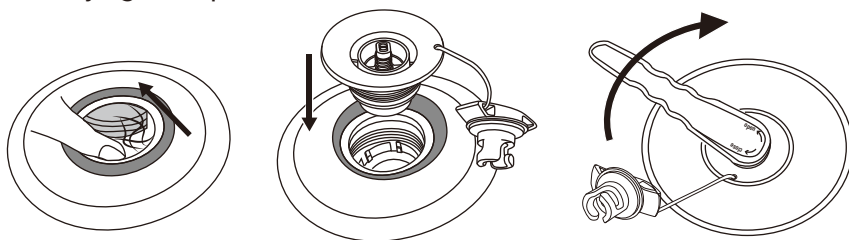

5. Asegúrese de que no haya puntadas sueltas del material cosido
6. Tenga en cuenta que la pieza inferior de la válvula no va sujeta a nada
7. Coloque la válvula de nuevo en la tabla
8. Alinee todas las roscas y gire para apretar
9. Una vez que la válvula se aprieta con la mano, use la llave de la válvula para sellar completamente



NOTA: Use correctamente la llave presionándola con una mano en la parte superior.

GARANTÍA

2
AÑO

AM extiende al comprador original esta garantía de que este producto está libre de defectos significativos en cuanto a materiales o mano de obra por un plazo de **2 años** (SOLAMENTE la tabla) a partir de la fecha de compra. Esta garantía está sujeta a las siguientes limitaciones.

1. La garantía es válida solo cuando este producto se usa para actividades recreativas normales y no cubre los productos utilizados para alquiler o excursiones escolares.
2. AM tomará la determinación final de la garantía, lo que puede requerir la inspección y/o fotos del equipo, que muestren claramente el (los) defecto (s). Si es necesario, esta información debe enviarse al distribuidor de AM en su país con franqueo prepagado. El producto puede devolverse solo si el distribuidor de AM proporciona un número de autorización de devolución por adelantado. El número de autorización de devolución debe estar claramente etiquetado en el exterior del paquete, o será rechazado.
3. Si AM considera que un producto es defectuoso, la garantía solamente cubre la reparación o el reemplazo del producto defectuoso. AM no será responsable de ningún costo, pérdida o daño incurrido como resultado de la pérdida o mal uso de este producto.
4. Esta garantía no cubre daños causados por uso indebido, abuso, negligencia, desgaste normal incluyendo, entre otros, punciones, daños por exposición excesiva al calor, daños causados por manipulación y almacenamiento incorrectos, daños causados por el uso en olas o en la costa con rompimiento de olas, rotura de la tabla causada por el llenado o el derrumbamiento en condiciones de oleaje, o daños causados por cualquier cosa que no sean defectos en materiales y mano de obra.
5. Este producto no debe ser modificado y/o equipado con un motor, excepto la aleta de potencia AM BlueDrive.
6. Este producto no debe usarse superando la capacidad de carga máxima recomendada por los fabricantes.
7. Esta garantía quedará anulada si se realiza alguna reparación, cambio o modificación no autorizada en cualquier parte del equipo.
8. La garantía de cualquier equipo reparado o reemplazado es válida solamente desde la fecha de la compra original.
9. El recibo de compra original debe acompañar todos los reclamos de garantía. El nombre del minorista y la fecha de compra deben ser claros y legibles.
10. No hay garantías que se extiendan más allá de la garantía especificada aquí.



ADVERTENCIA

Este producto está diseñado de acuerdo con las normas para un uso específico. Cualquier modificación o transformación superior a la indicada por el fabricante podría generar riesgos graves para el usuario y anulará la garantía.