

DALLAS A / DALLAS A Mix 2016

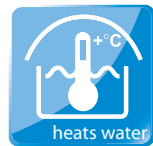

REVIZE: 5. 2. 2016



BG
 Тръгването на Съюзните държави е разрешено
 в България с АНДХА - № F 90-300
 За повече информация относно условията за продажба и монтаж, моля да се свържете с местния представител на ALBIXON в България.

DE
 Schwimmplatzüberdachung ist keine Konstruktion
 Einbauzeit bei ANDHA: № F 90-300
 Die Zeit von der Montage bis zur Inbetriebnahme ist abhängig von der Größe der Anlage und der Art der Ausführung.
 Die Zeit von der Montage bis zur Inbetriebnahme ist abhängig von der Größe der Anlage und der Art der Ausführung.

ES
 Cubierta de piscina no es una construcción
 Construcción de ANDHA: № F 90-300
 El tiempo de instalación es variable en función de las características de la instalación y del tipo de ejecución.
 El tiempo de instalación es variable en función de las características de la instalación y del tipo de ejecución.

FR
 Hors de piscine, construction légère
 Construction de ANDHA: № F 90-300
 Le temps de montage est variable en fonction de la taille de l'installation et du type de montage.
 Le temps de montage est variable en fonction de la taille de l'installation et du type de montage.

HU
 Működési módok: könnyű konstrukció
 ANDHA: № F 90-300/működési módok
 A felépítési időtartam változó, az építési módoktól és az építési helytől függően.
 A felépítési időtartam változó, az építési módoktól és az építési helytől függően.

CN
 非结构、非承重
 非结构、非承重
 非结构、非承重
 非结构、非承重
 非结构、非承重
 非结构、非承重

LT
 Tvirtas vėži bazėnėms lengva konstrukcija
 Statyba su ANDHA: № F 90-300
 Pastatymo ir eksploatavimo laikas priklauso nuo plovimo patalpos dydžio ir montavimo būdų.
 Pastatymo ir eksploatavimo laikas priklauso nuo plovimo patalpos dydžio ir montavimo būdų.

PL
 Zadaszkielniek bazenów, lekki konstrukcja
 Statyba su ANDHA: № F 90-300
 Pastatymo ir eksploatavimo laikas priklauso nuo plovimo patalpos dydžio ir montavimo būdų.
 Pastatymo ir eksploatavimo laikas priklauso nuo plovimo patalpos dydžio ir montavimo būdų.

RU
 Тёплое время купания лёгкая конструкция
 Установка ANDHA: № F 90-300
 Время монтажа и эксплуатации зависит от размера бассейна и способа монтажа.
 Время монтажа и эксплуатации зависит от размера бассейна и способа монтажа.

SL
 Teplotno vreme kupanja, lahka konstrukcija
 Vgradnja ANDHA: № F 90-300
 Časovnik za montažo in uporabo je odvisen od velikosti bazena in načina montaže.
 Časovnik za montažo in uporabo je odvisen od velikosti bazena in načina montaže.

CZ
 Bezstruktúrné zariadenie ľahkej konštrukcie
 Vybavenie ANDHA: № F 90-300
 Doba na montáž a prevádzku závisí od veľkosti bazena a spôsobu montáže.
 Doba na montáž a prevádzku závisí od veľkosti bazena a spôsobu montáže.

DK
 Bænkoverdækning, let konstruktion
 Tidsplanlægning med ANDHA: № F 90-300
 Den tid der kræves for montage og drift afhænger af størrelsen på bassen og monteringsmåden.
 Den tid der kræves for montage og drift afhænger af størrelsen på bassen og monteringsmåden.

EE
 Kõhvikõhikud, lihtsaim konstruktsioon
 Aeg ANDHA: № F 90-300
 Paigaldamise ja kasutamise aeg sõltub basseinide suurusest ja paigaldamisviisist.
 Paigaldamise ja kasutamise aeg sõltub basseinide suurusest ja paigaldamisviisist.

GB
 The swimming pool enclosure is not a construction
 Installation of ANDHA: № F 90-300
 The time taken for installation and operation depends on the size of the pool and the way it is installed.
 The time taken for installation and operation depends on the size of the pool and the way it is installed.

HR
 Nestrukturirane bazeno lak konstrukcija
 Statyba su ANDHA: № F 90-300
 Povešeno vrijeme za montažu i korištenje ovisi o veličini bazena i načinu postavljanja.
 Povešeno vrijeme za montažu i korištenje ovisi o veličini bazena i načinu postavljanja.

IT
 Copertura per piscine, costruzione leggera
 Statyba su ANDHA: № F 90-300
 Tempo di montaggio e di utilizzo dipende dalle dimensioni della piscina e dal modo di installazione.
 Tempo di montaggio e di utilizzo dipende dalle dimensioni della piscina e dal modo di installazione.

LV
 Bāzēnīšu jumts: viegla konstrukcija
 Statyba su ANDHA: № F 90-300
 Pārvaldības un ekspluatācijas laiks ir atkarīgs no baseina izmēriem un uzstādīšanas veida.
 Pārvaldības un ekspluatācijas laiks ir atkarīgs no baseina izmēriem un uzstādīšanas veida.

RO
 Acoperitură pentru piscină, construcție ușoară
 Instalarea ANDHA: № F 90-300
 Durata de instalare și utilizare depinde de dimensiunile piscine și de metoda de instalare.
 Durata de instalare și utilizare depinde de dimensiunile piscine și de metoda de instalare.

SE
 Pooltak, lätt konstruktion
 Tidsplanering med ANDHA: № F 90-300
 Tiden för installation och drift beror på bassinens storlek och monteringsmetoden.
 Tiden för installation och drift beror på bassinens storlek och monteringsmetoden.

SK
 Bezstruktúrné zariadenie ľahkej konštrukcie
 Vybavenie ANDHA: № F 90-300
 Doba na montáž a prevádzku závisí od veľkosti bazena a spôsobu montáže.
 Doba na montáž a prevádzku závisí od veľkosti bazena a spôsobu montáže.

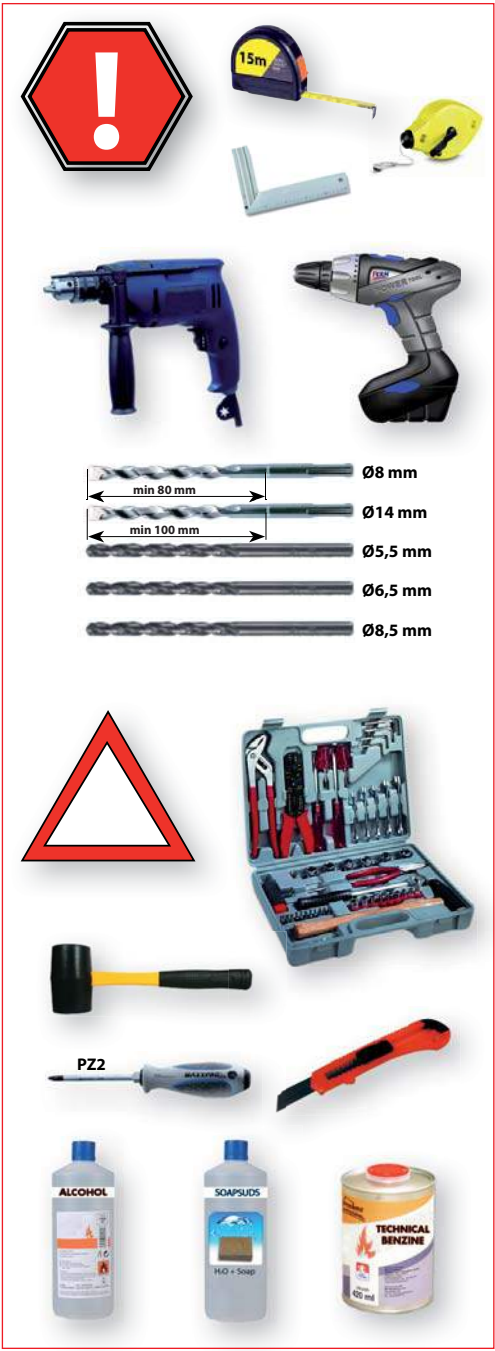

DIN 7982
4,8 x 13
16x
1

650.01.8811.2

12x
2

AN 9051
6,3 x 50
28x
3

007.20.1501.2

5x
4

DIN 7976
6,3 x 38
5x
5

650.01.0021.2

4x
6

007.02.0030.2

ø4 x 10
36x
7

007.20.1605.2

1x
8

007.10.7012.2

ø8 x 80
48x
9

007.02.0092.2

ø4 x 14
4x
11

007.90.4505.2

4x
12

6,3 x 38
16x
13

ø4,2
1x
14

1x
15

1x
16

1x
17

1x
18

097.02.0040.2

2x
19

097.02.0041.2

2x
20

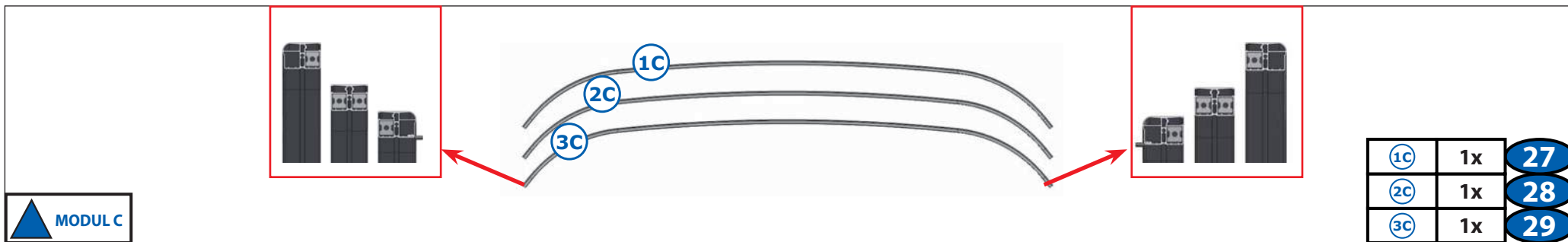
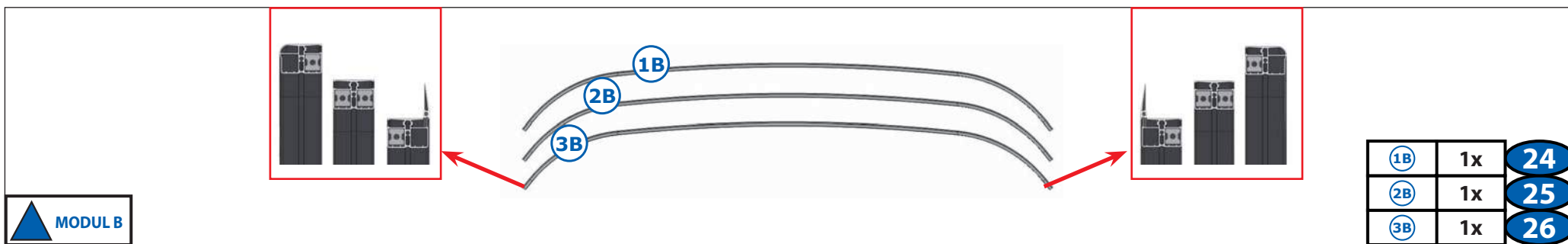
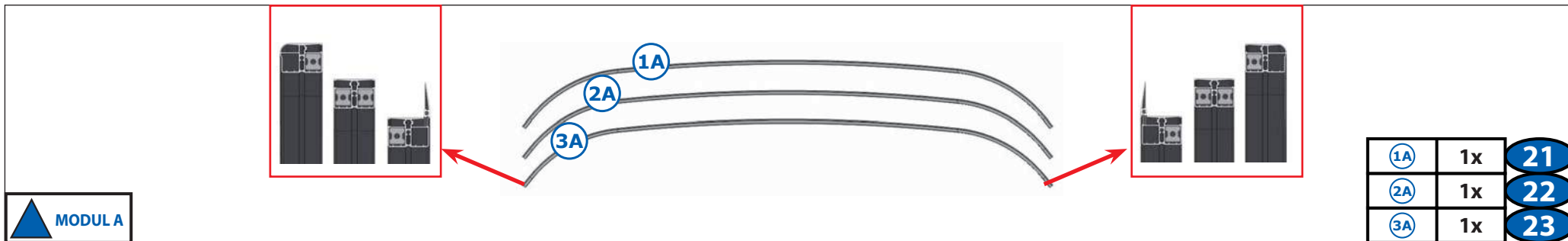
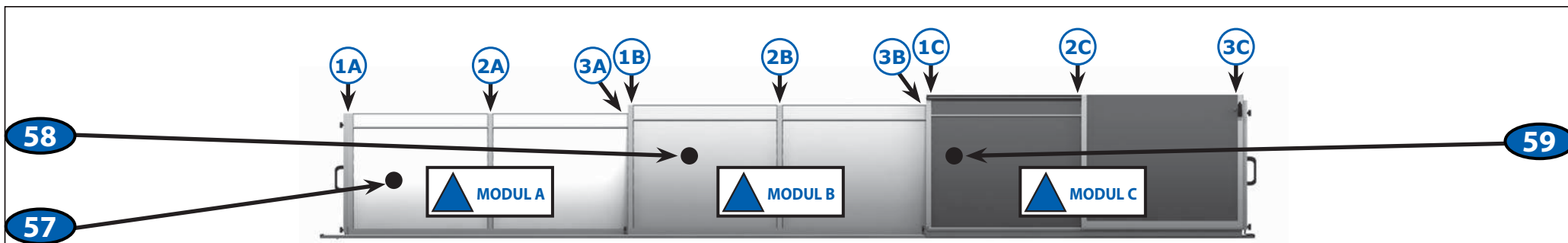





1041 mm
16x
36





A
3230 mm
2x
40

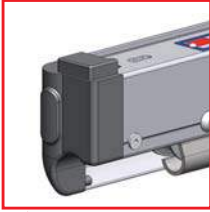
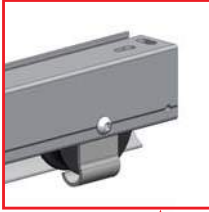



D
3230 mm
2x
46



3230 mm
12x
48

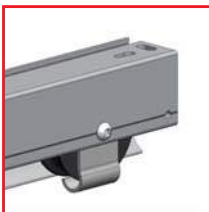

			
			
MODUL C			
1x			
50			

			
			
MODUL C			
1x			
51			

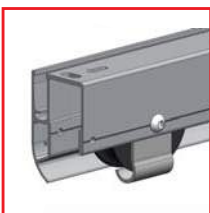
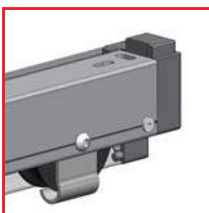
			
			
MODUL B			
1x			
52			

			
			
MODUL B			
1x			
53			



MODUL A

1x
54

MODUL A

1x
55

MODUL A

4102 x 1049 mm

2x
57

MODUL B

4301 x 1049 mm

2x
58

MODUL C

2245 x 1049 mm

3x
59

MODUL C

2198 x 1049 mm

1x
60

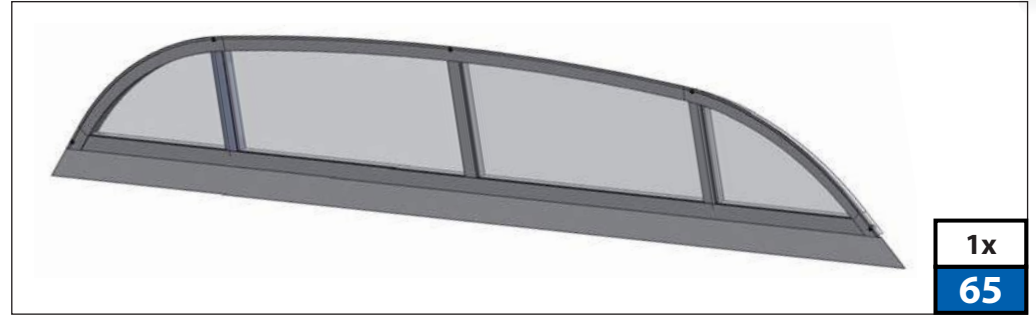
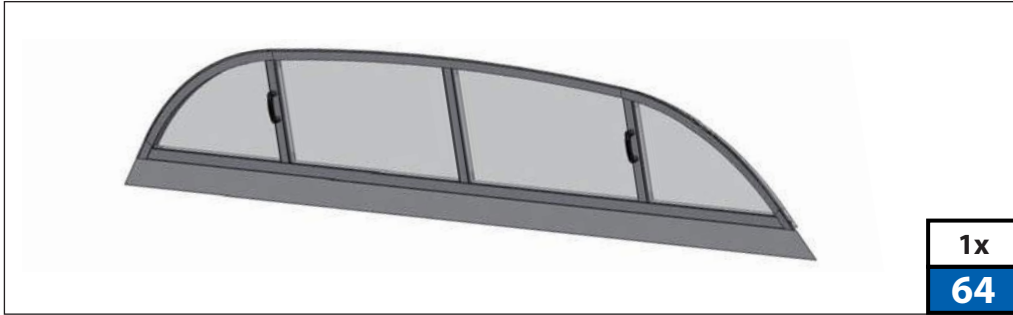



1x
69

1x
70

1x
2150 mm **71**

1x
2150 mm **72**

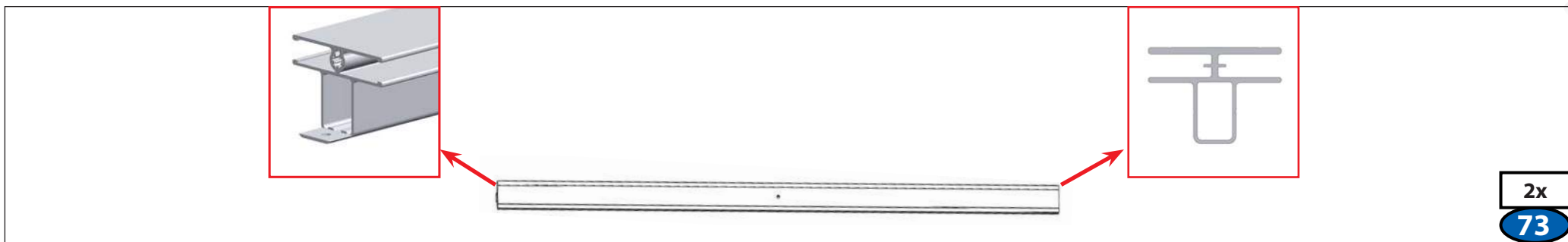

2x
73

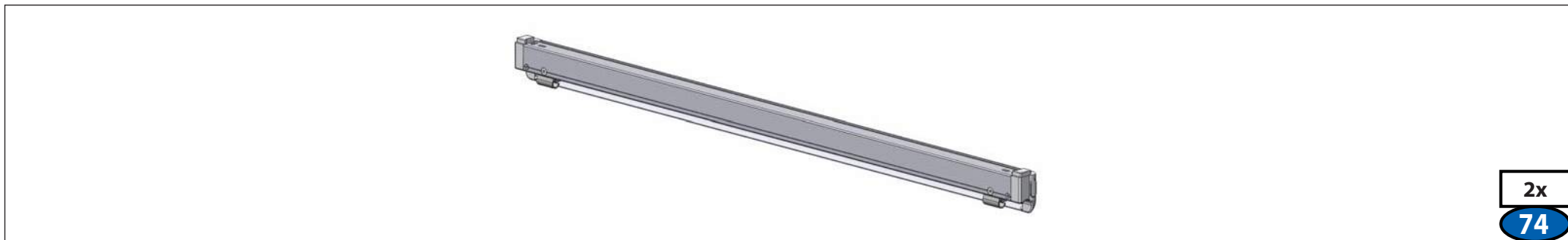

2x
74

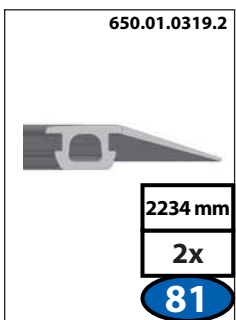
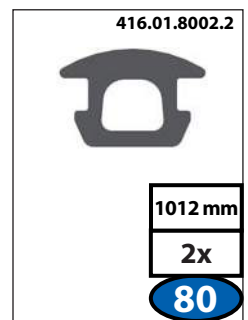
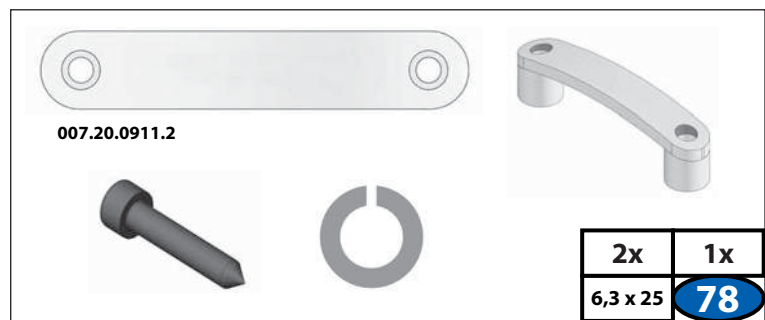
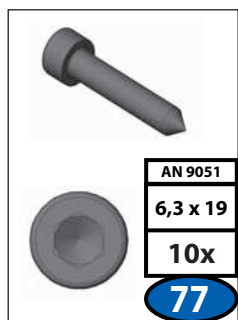
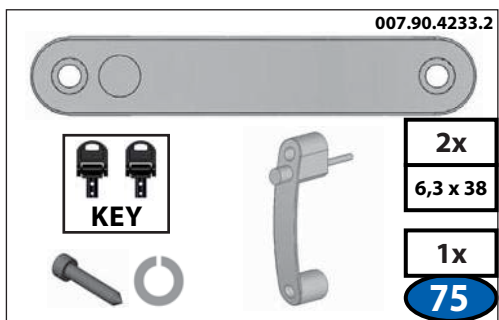

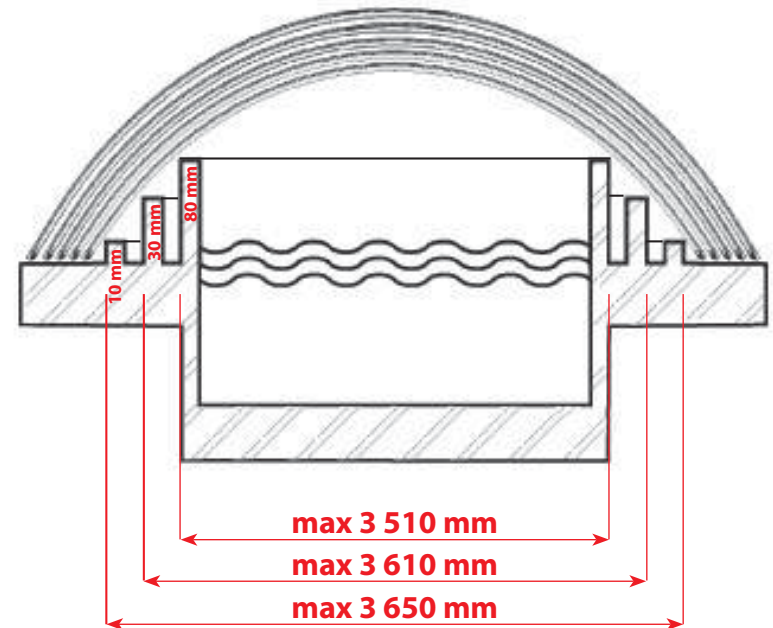
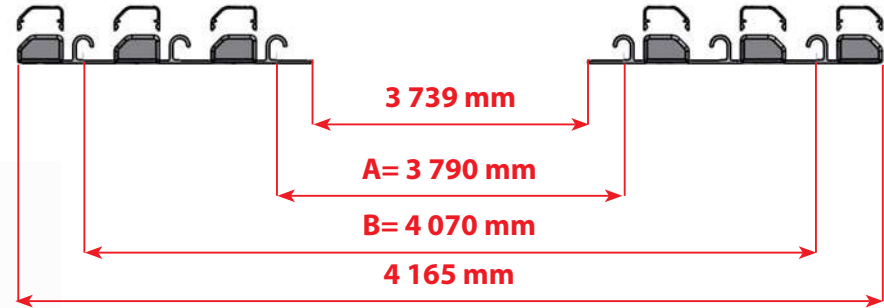
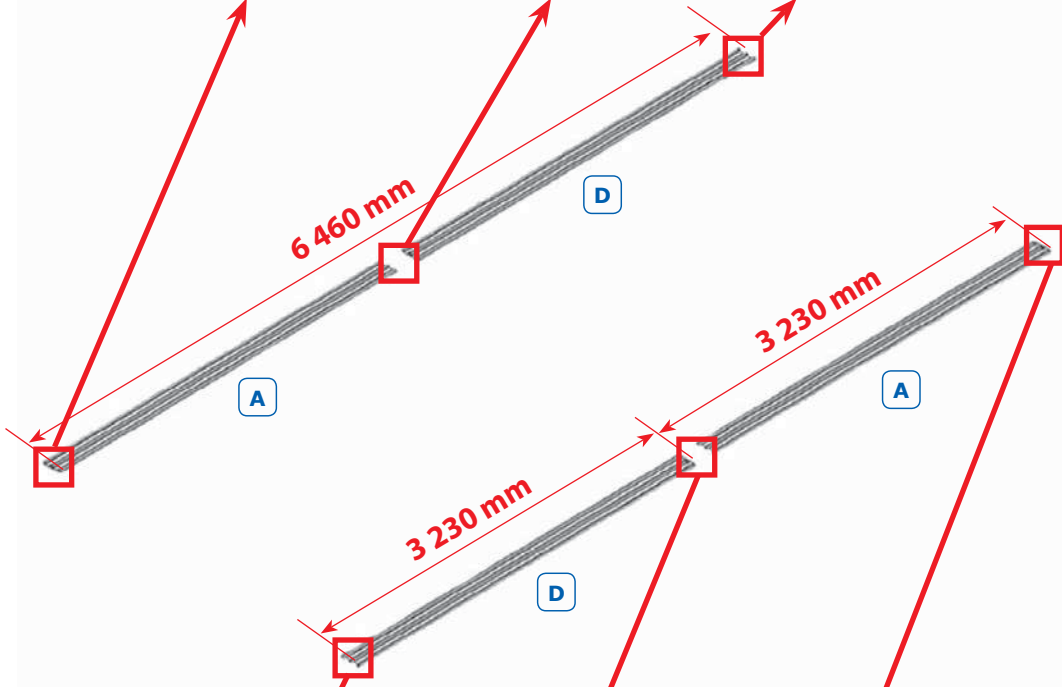
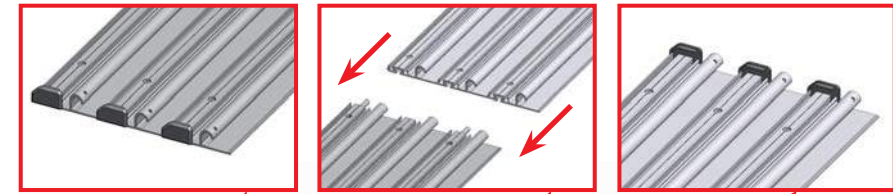

2x	41
2x	47

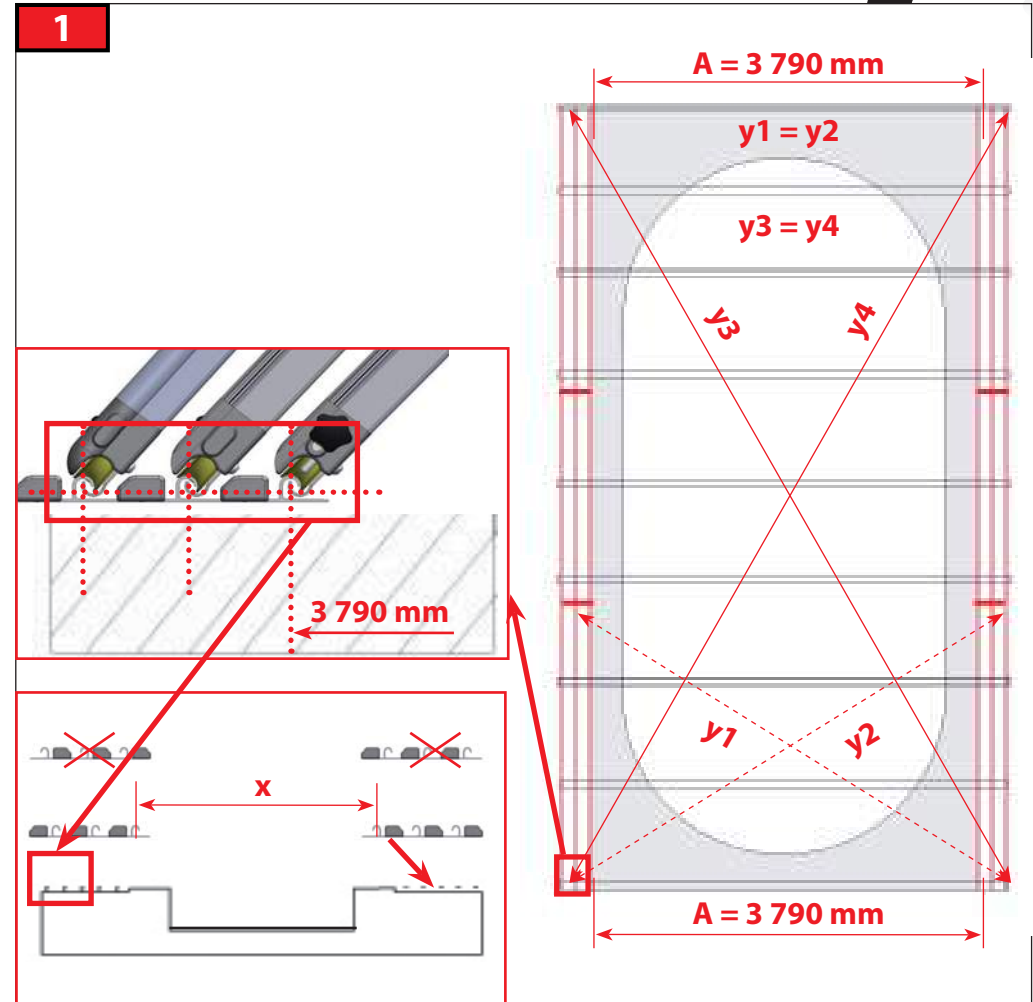
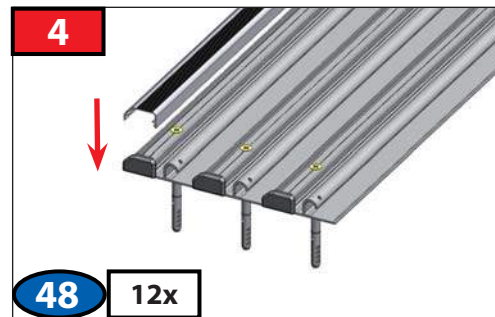
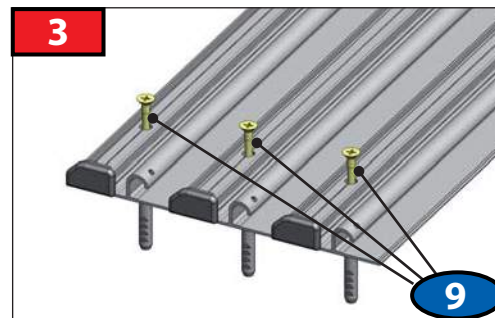
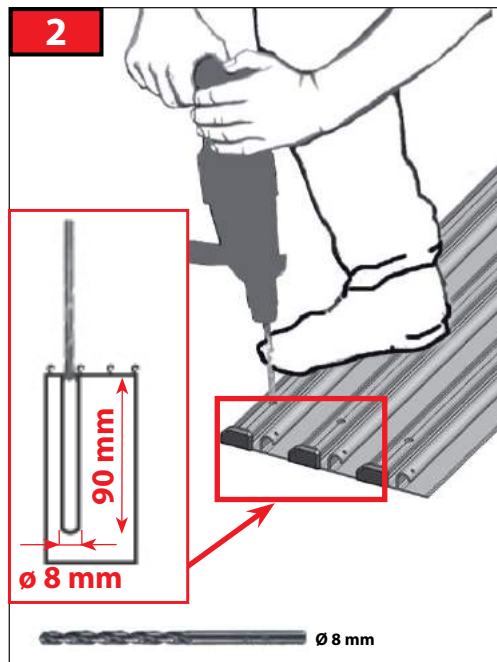
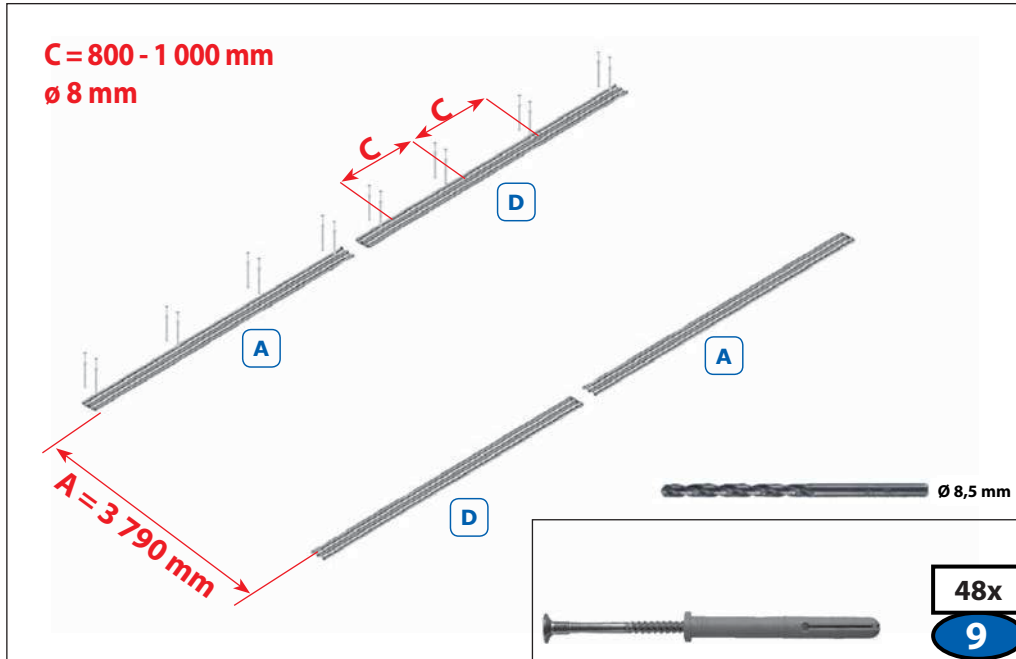

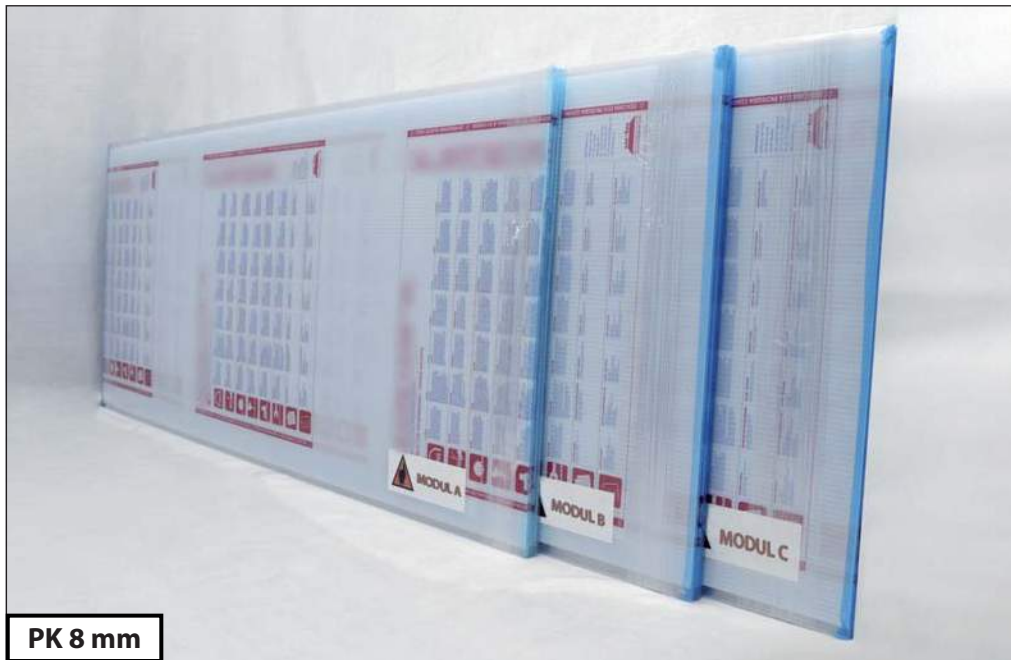

PK 8 mm

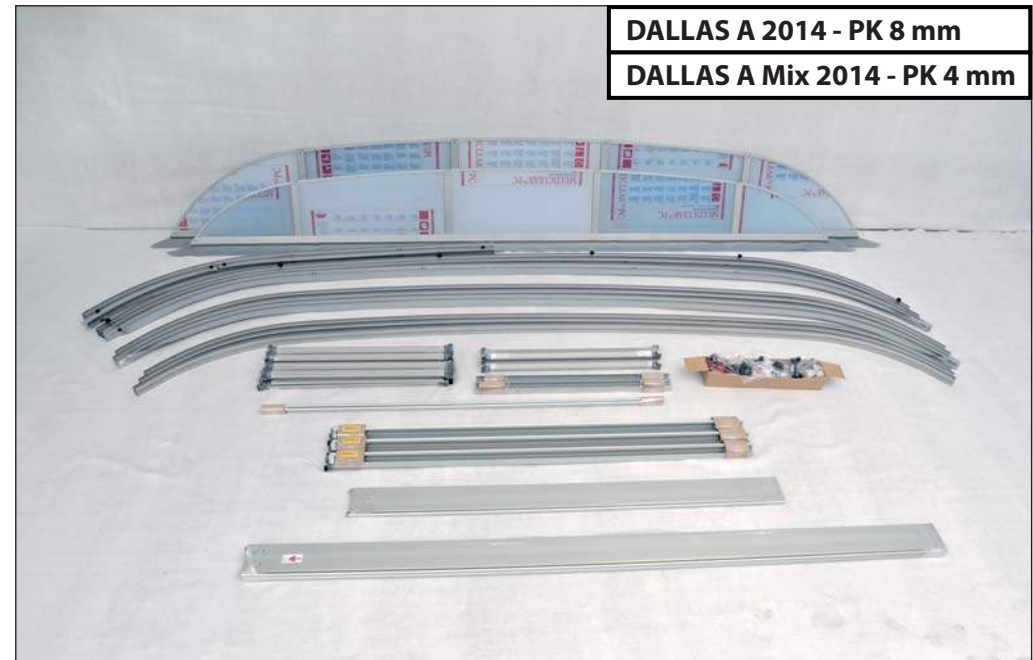

DALLAS A 2014 - PK 8 mm
DALLAS A Mix 2014 - PK 4 mm

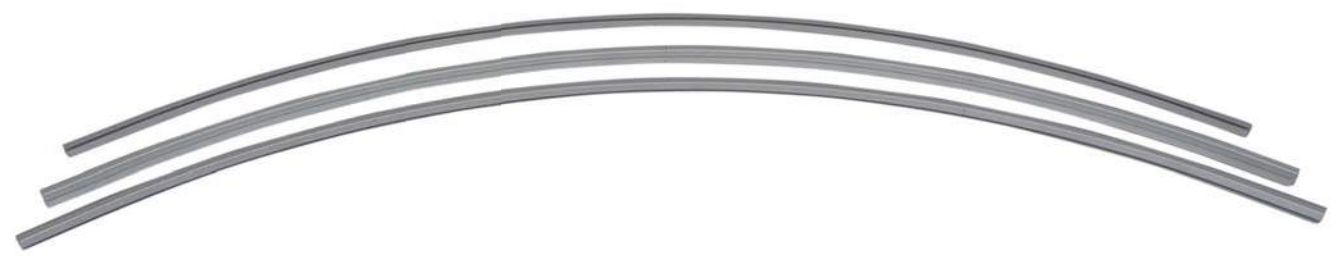
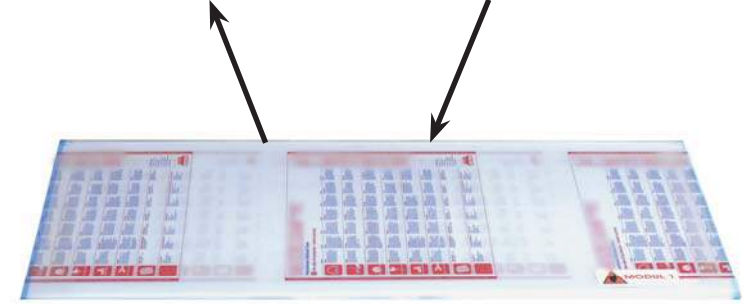
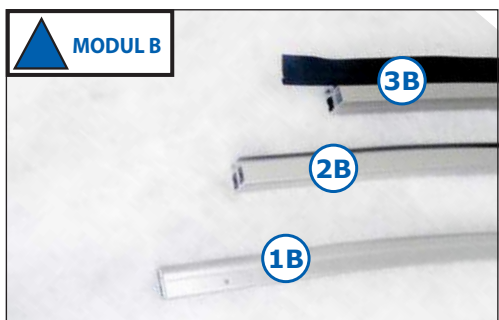
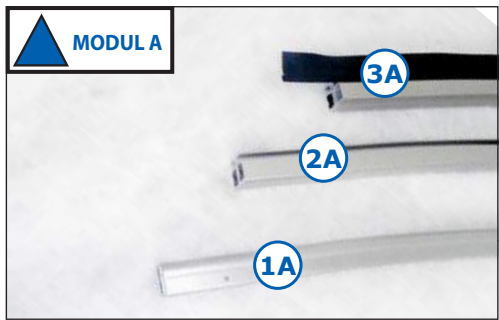
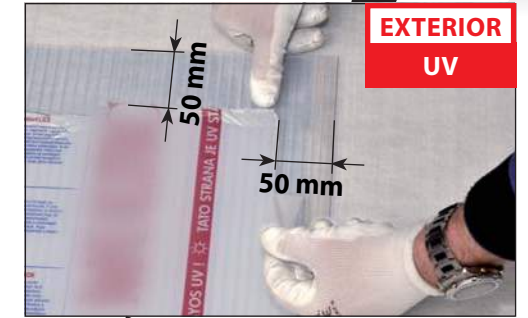

36

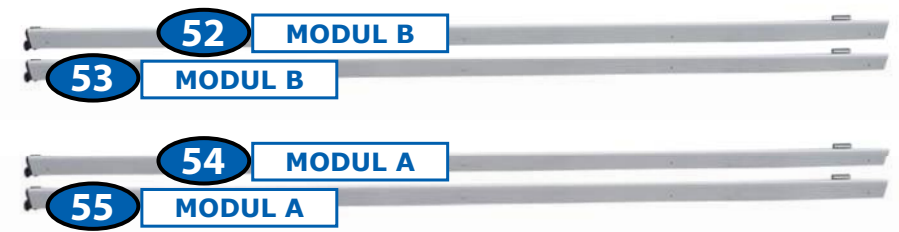
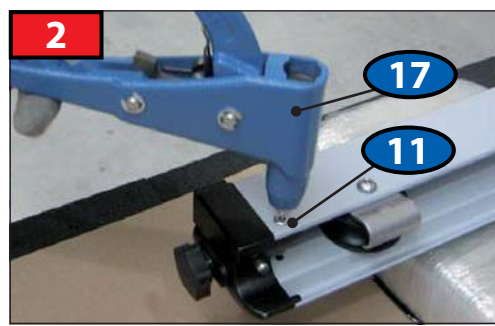
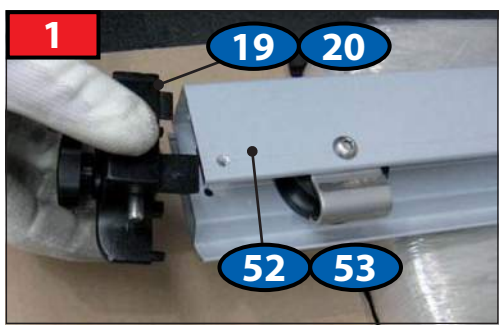

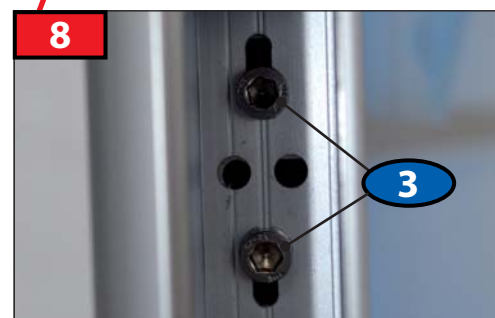
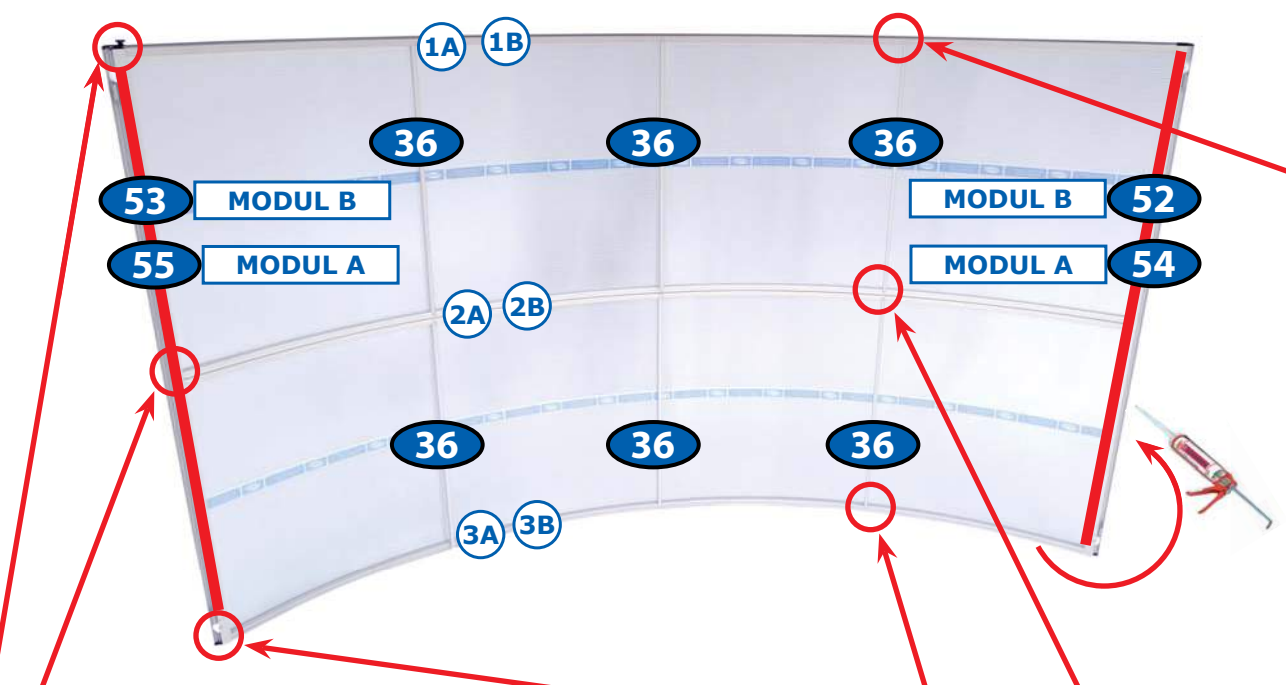
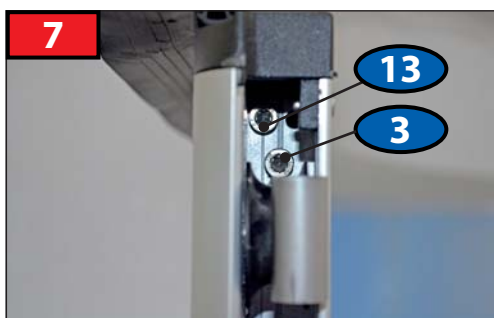
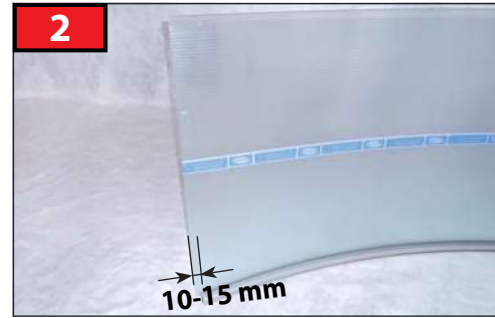

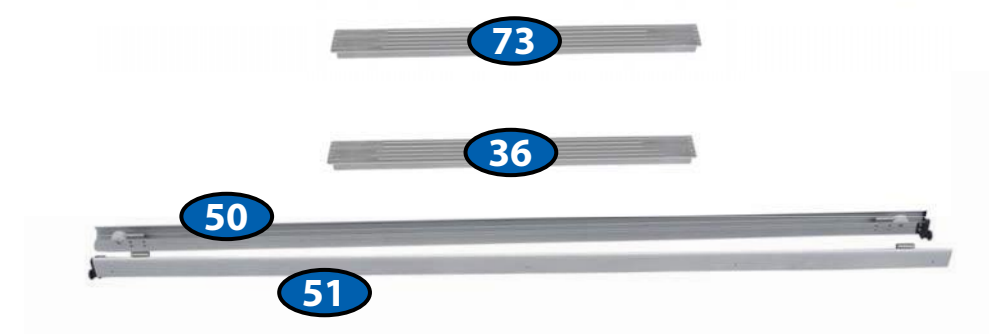
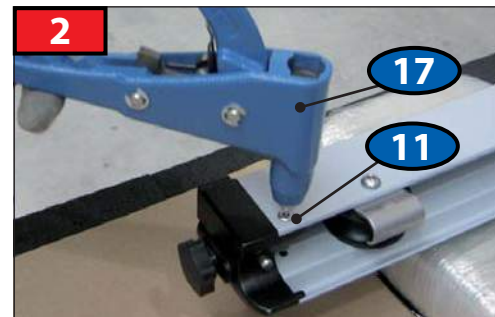
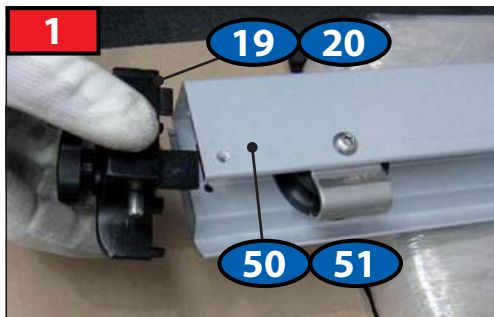
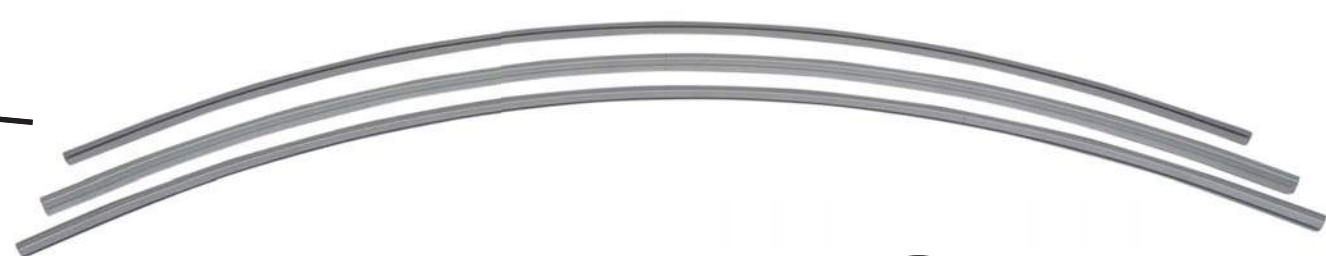
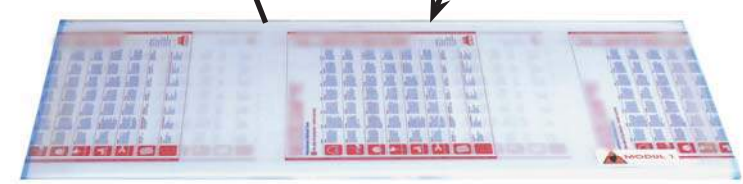
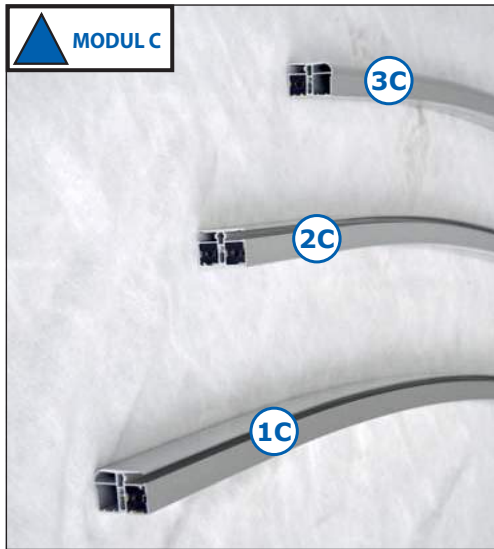
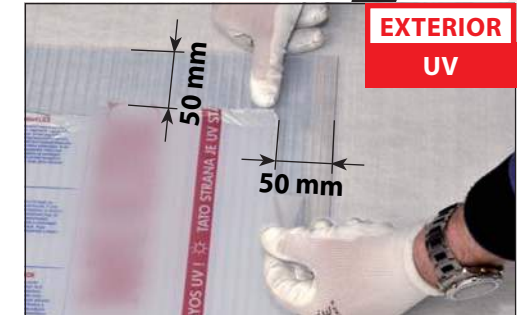



DOOR LEFT

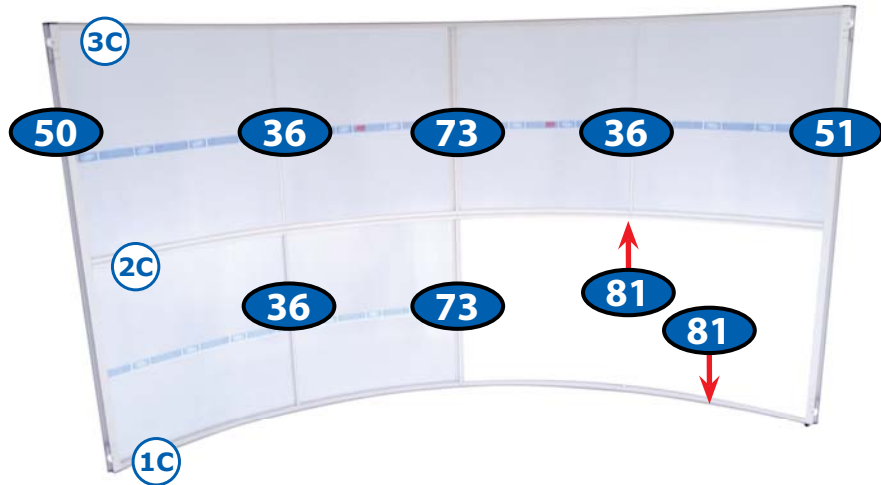
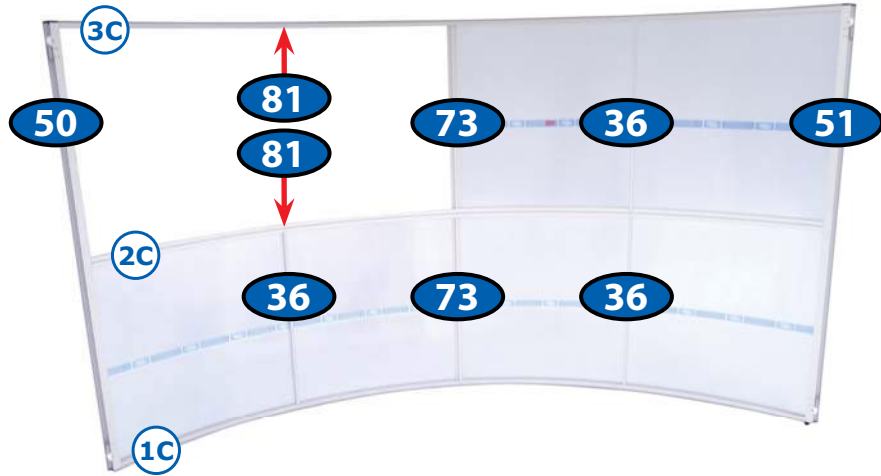

DOOR RIGHT

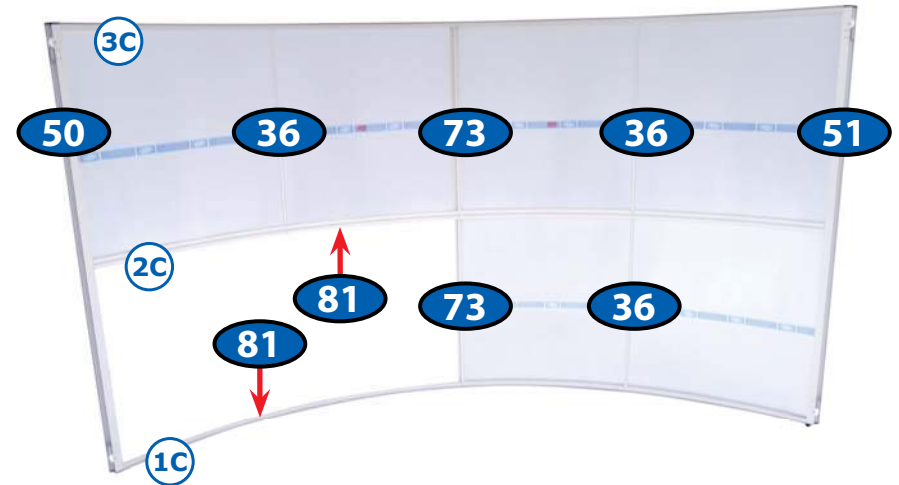
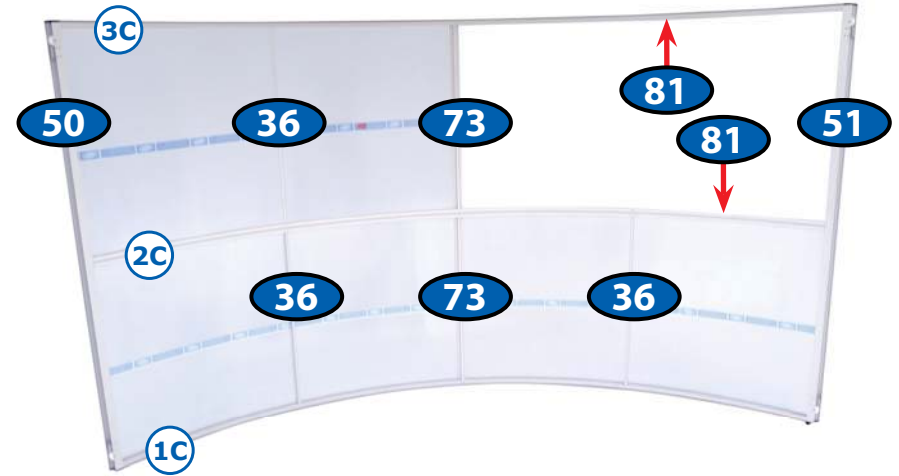

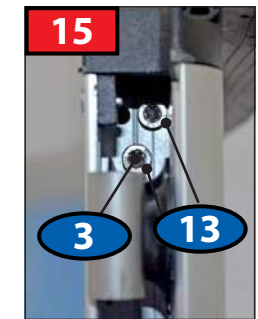
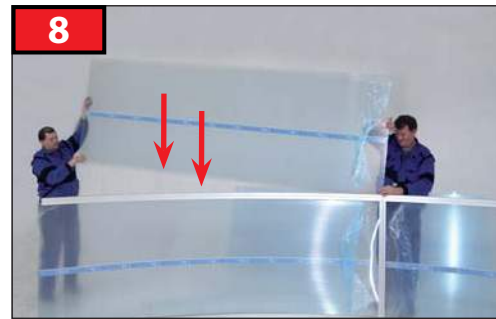
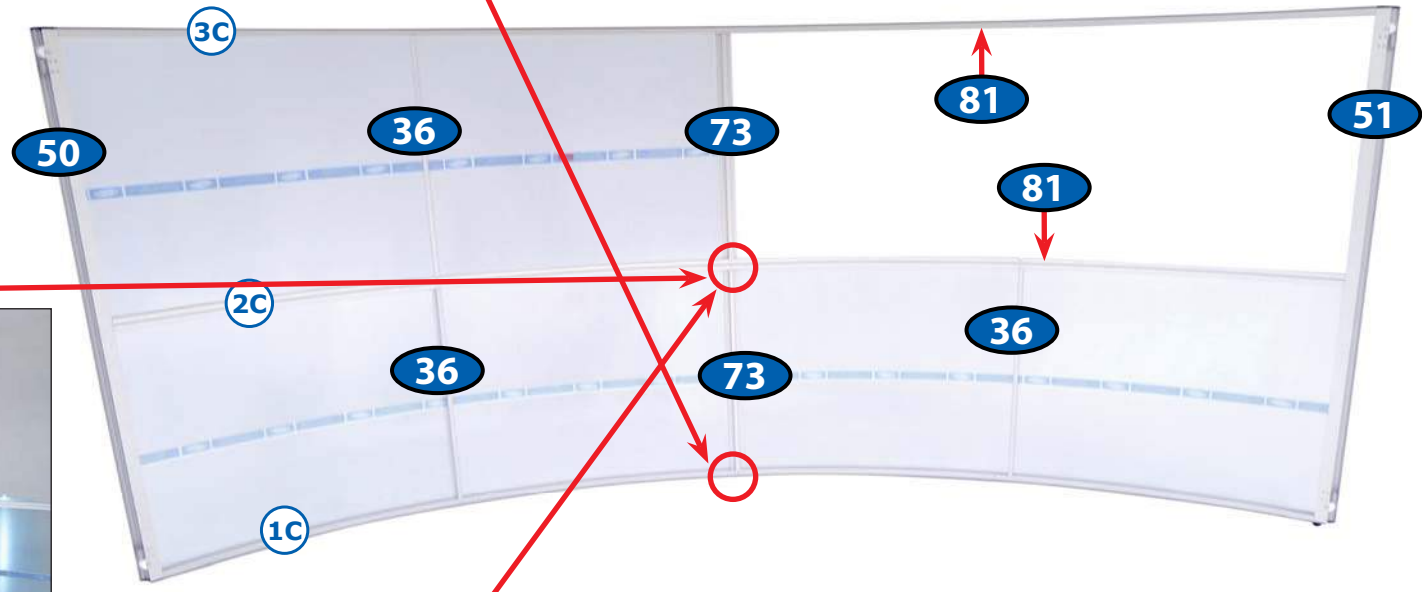
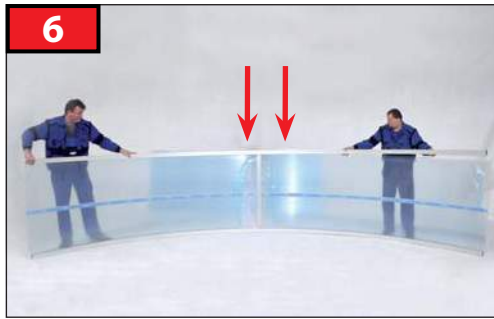

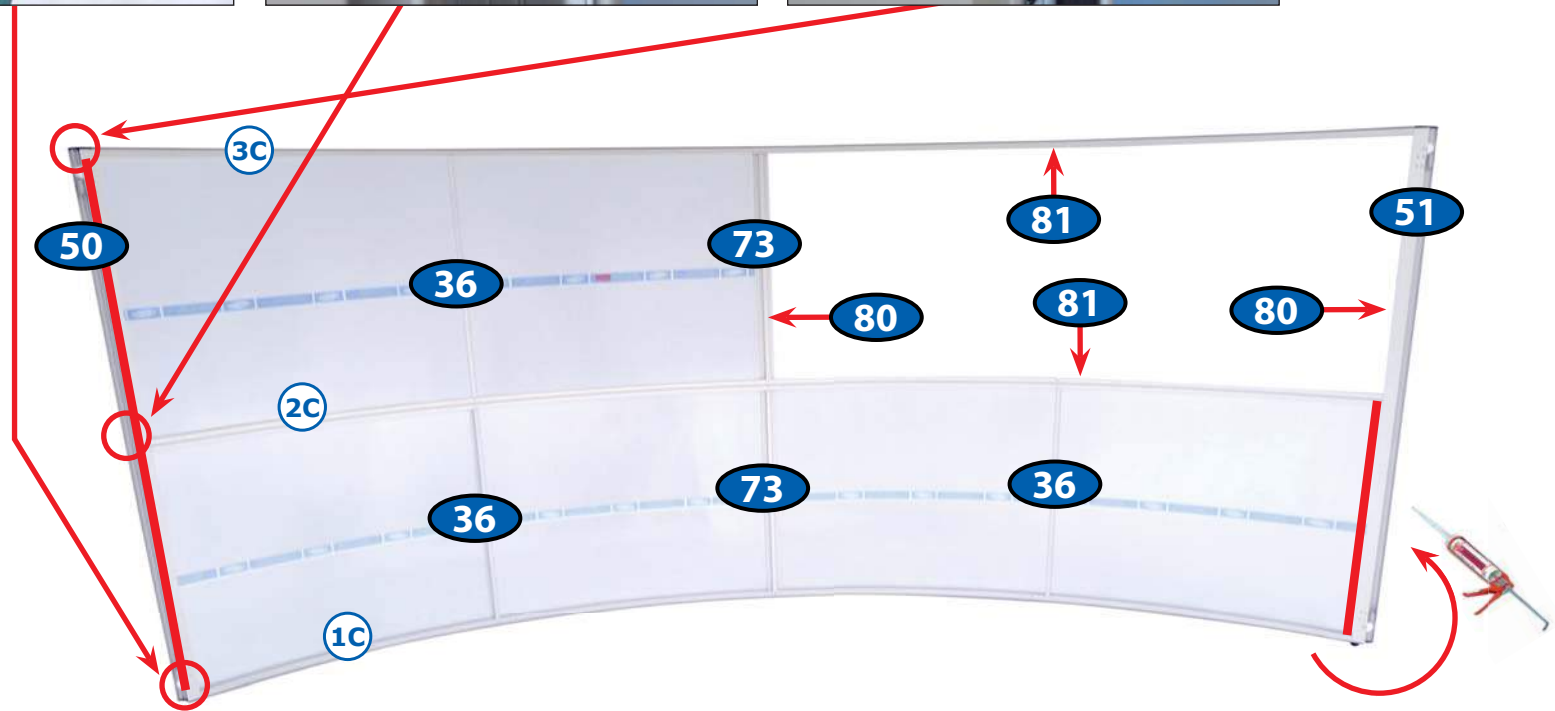
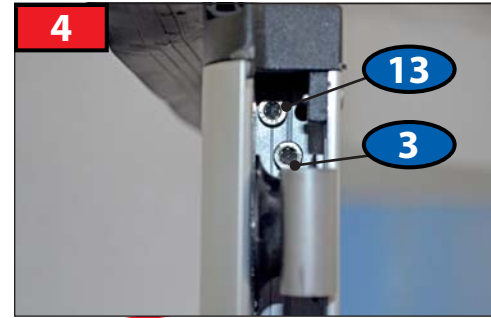
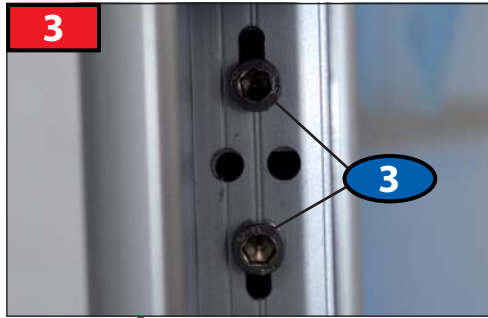
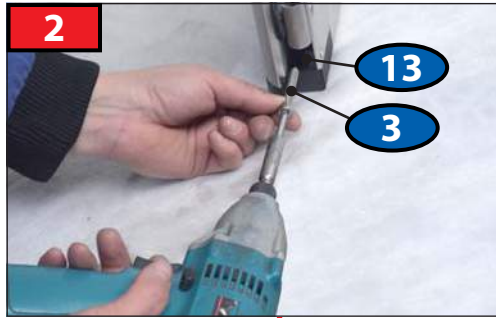

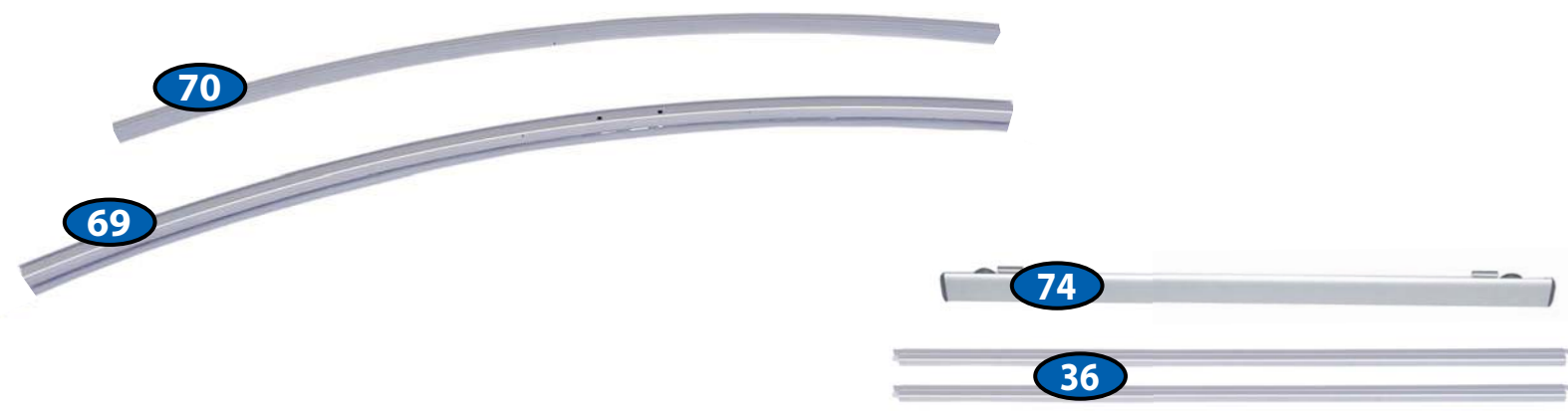
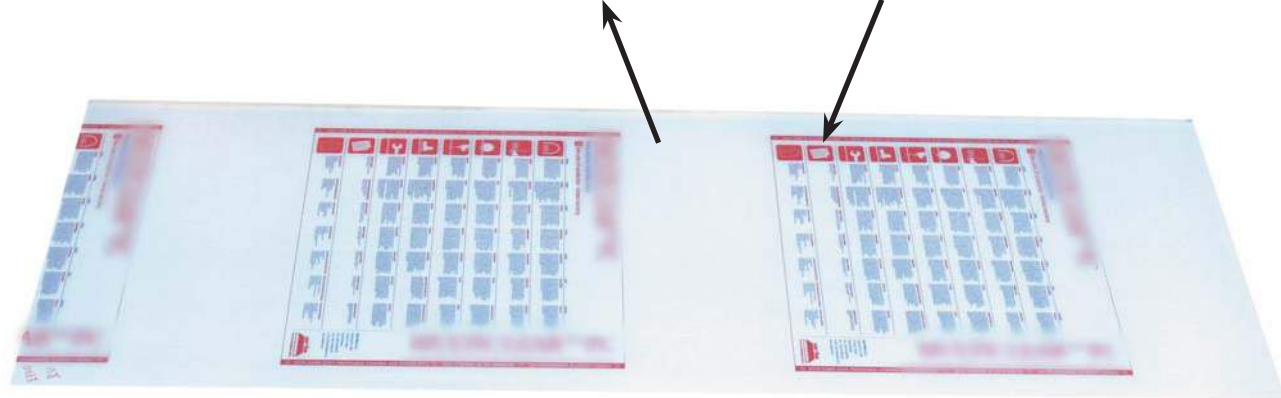
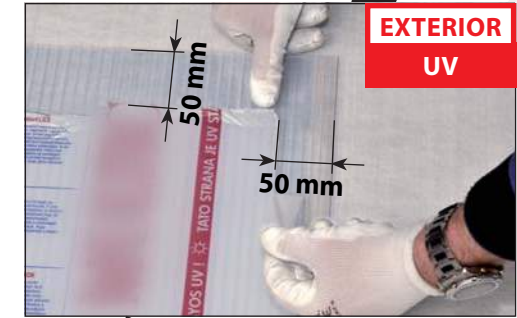
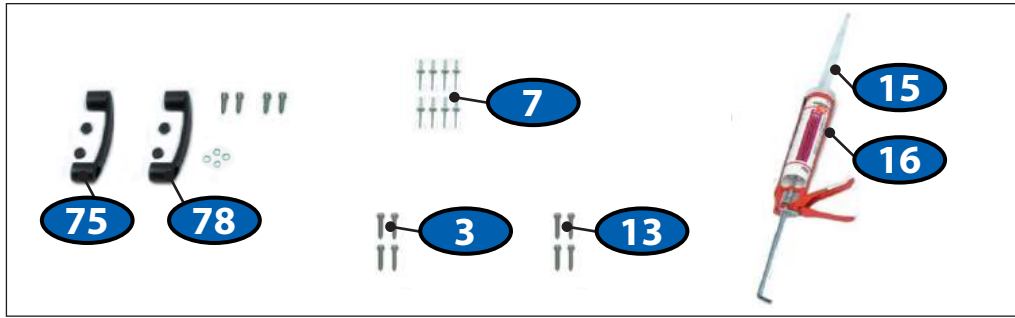

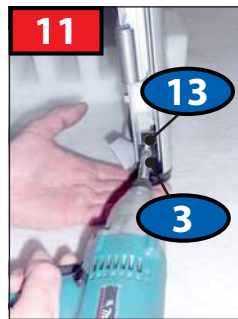
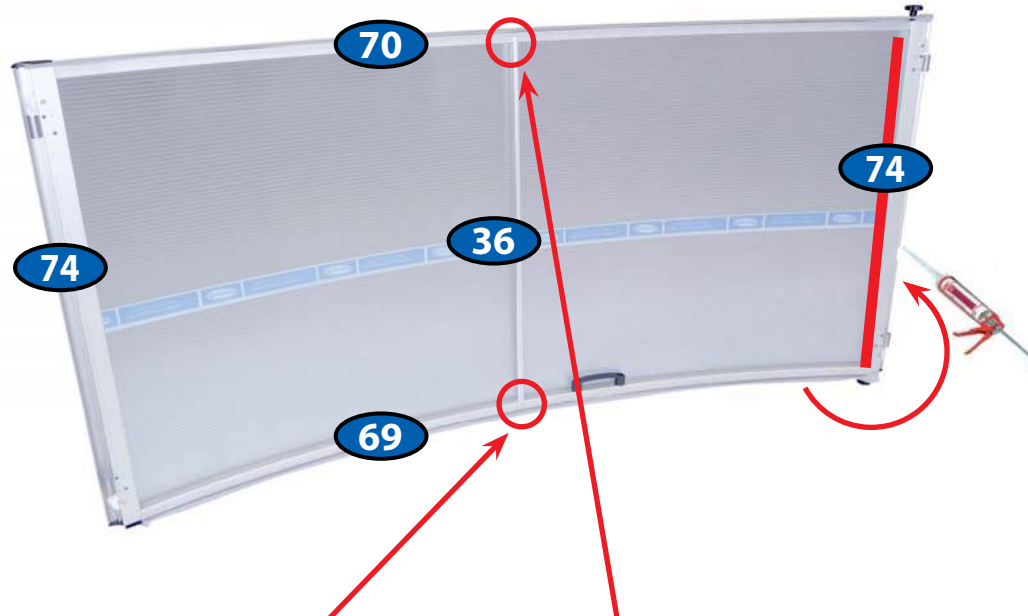
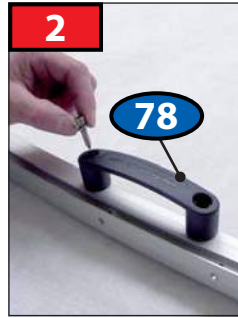

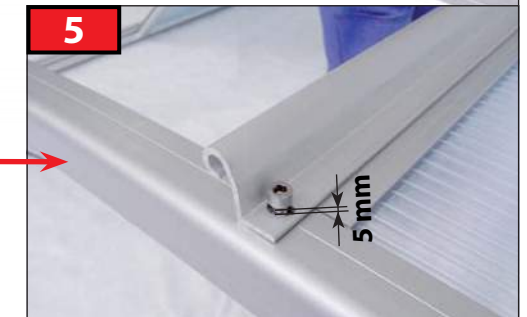
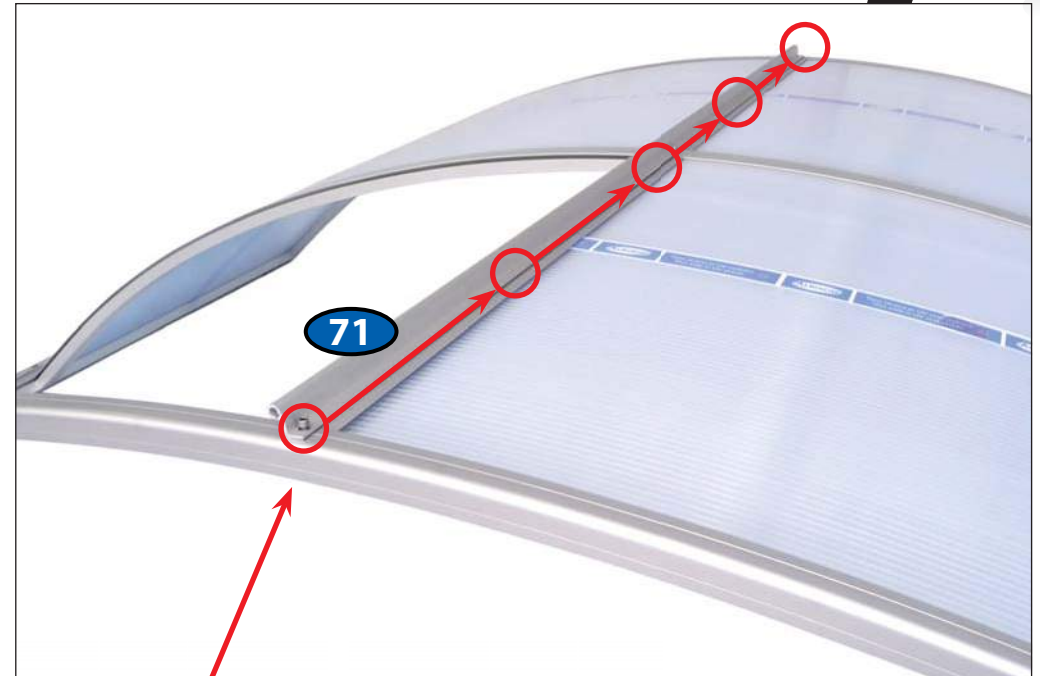

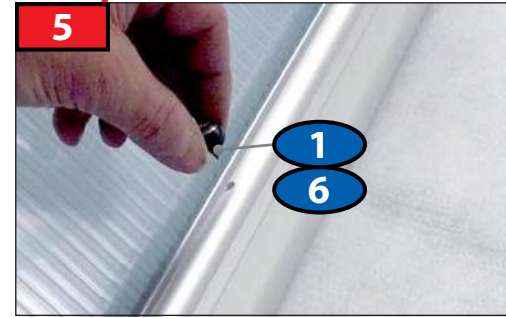
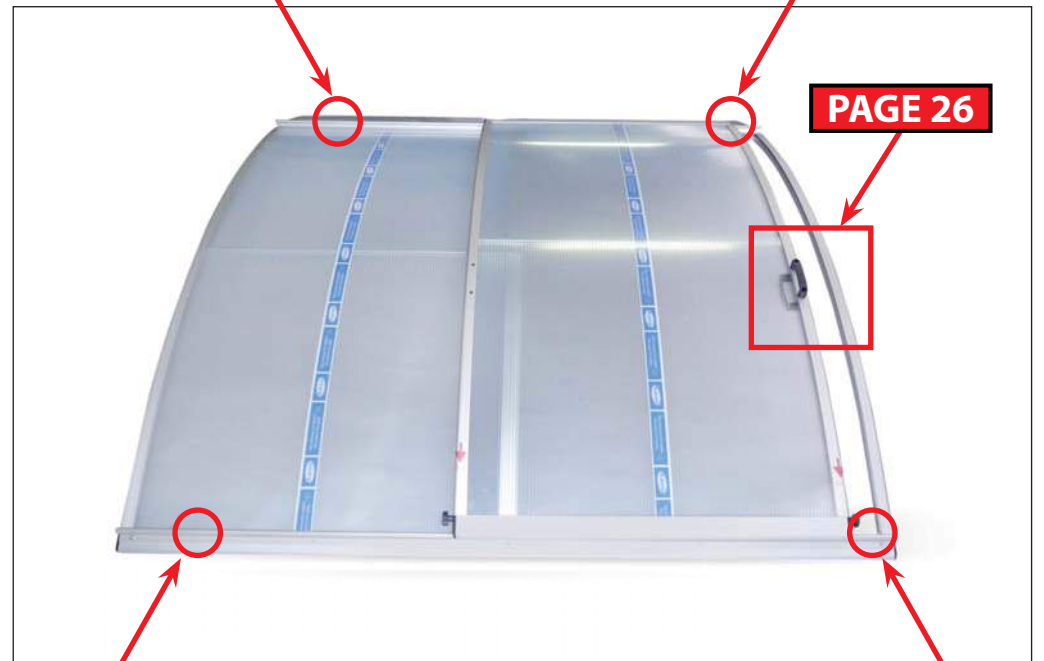
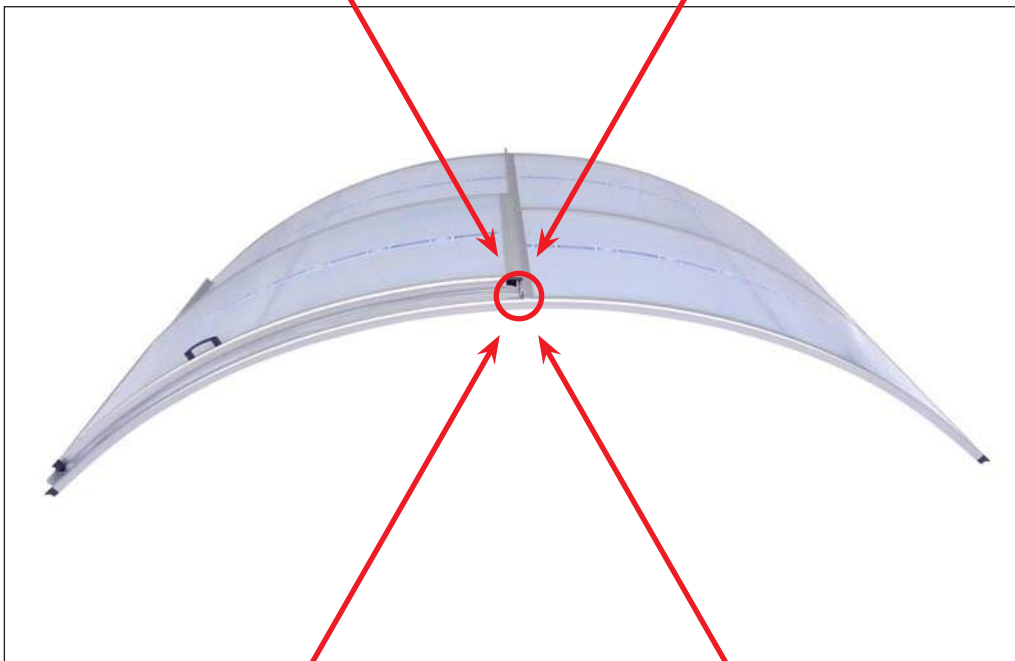
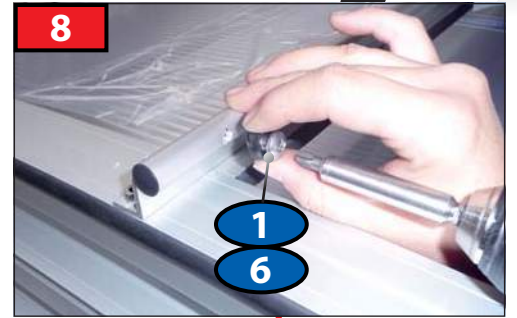

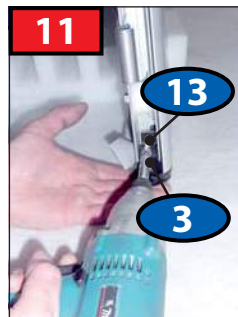
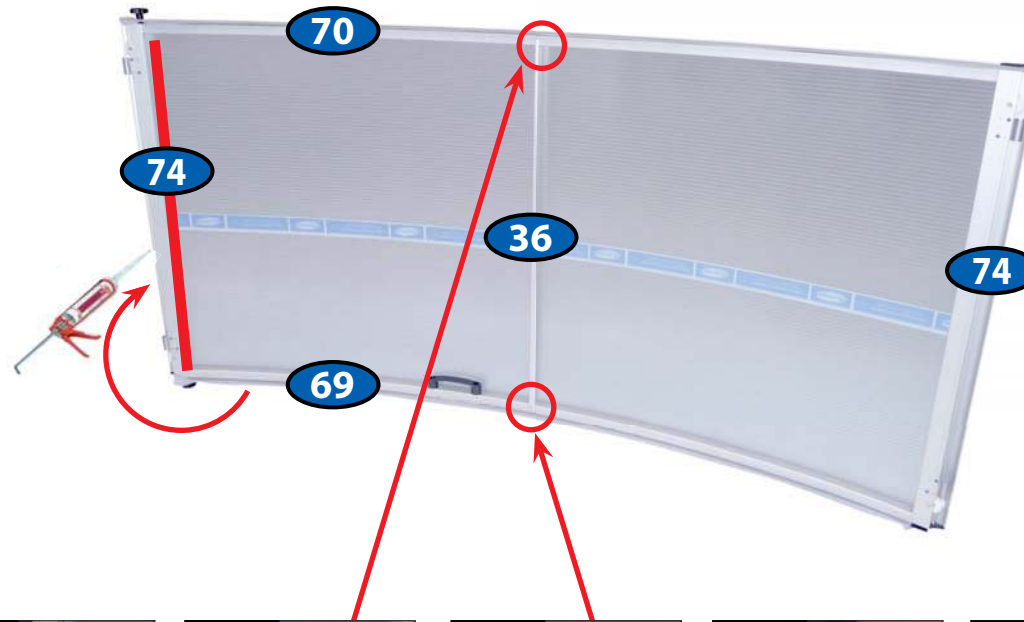
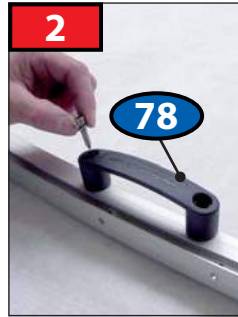

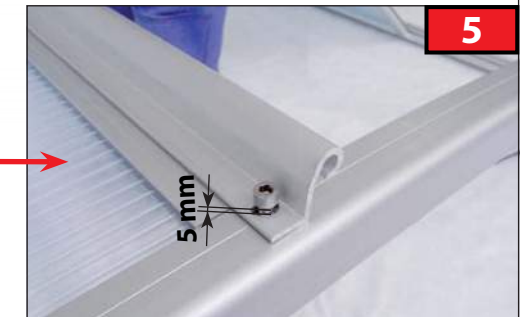
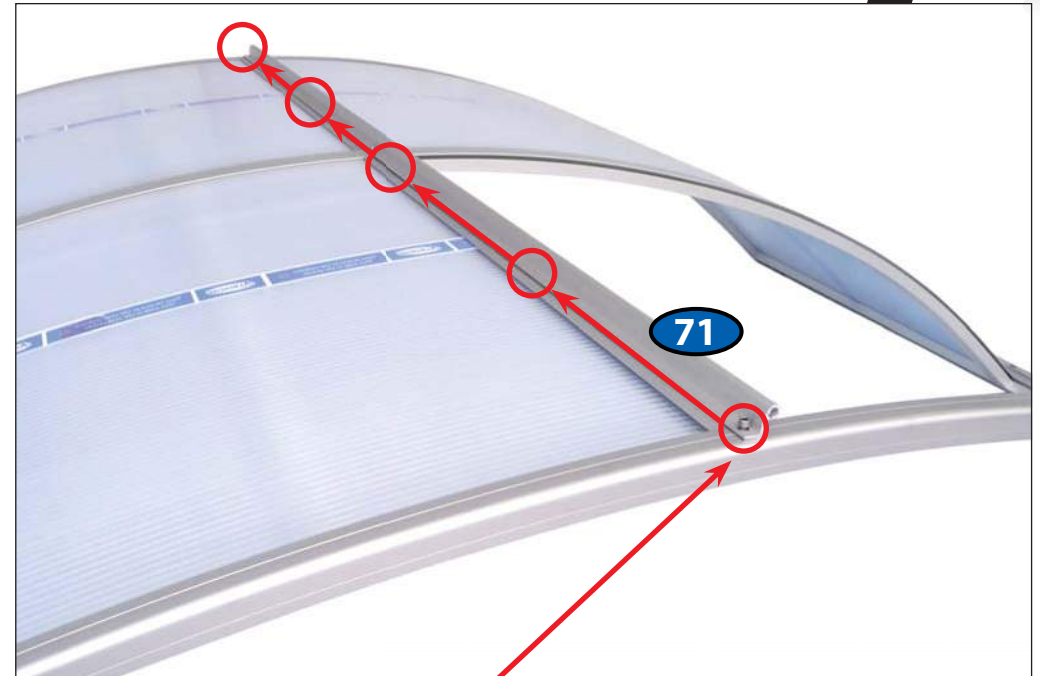

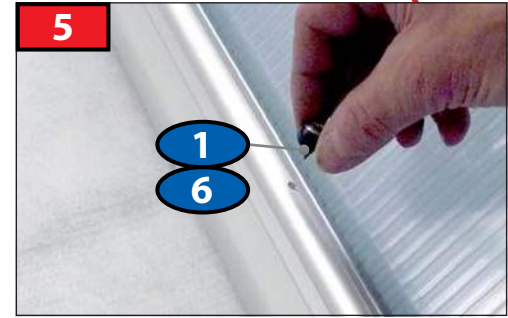
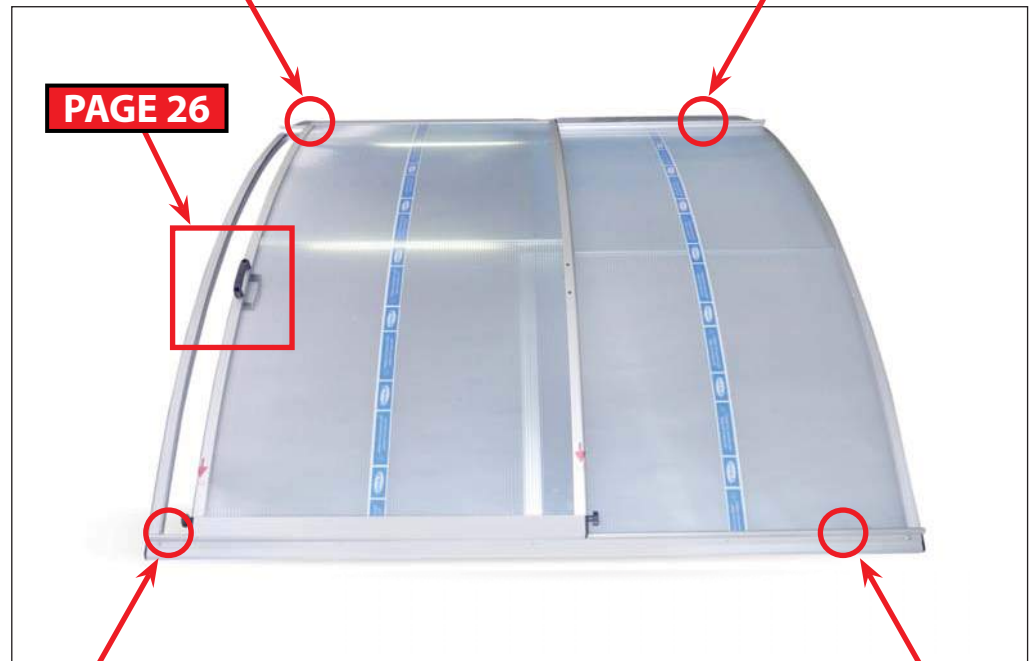
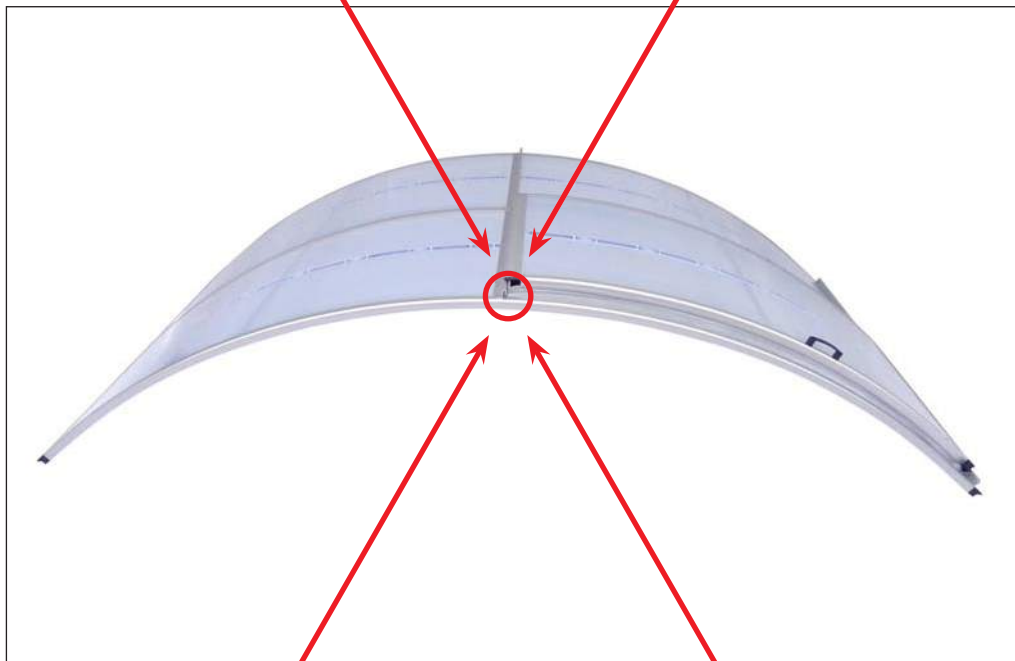
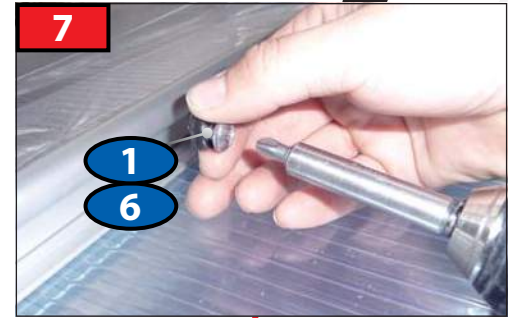
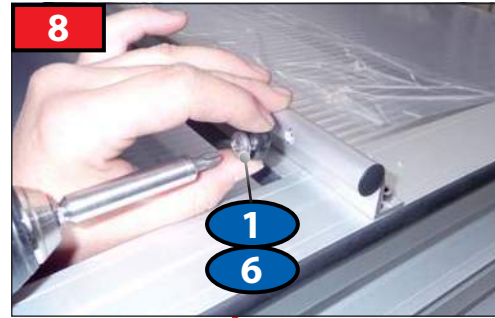
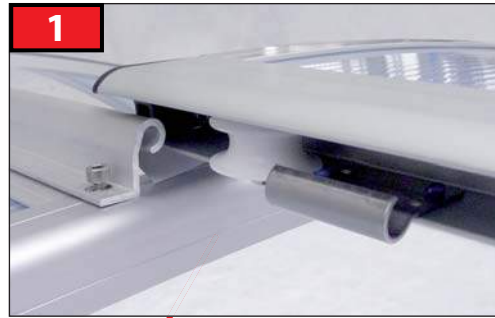

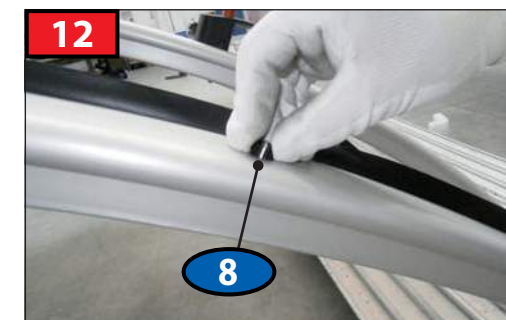
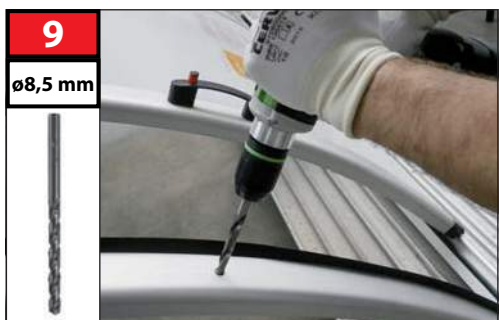
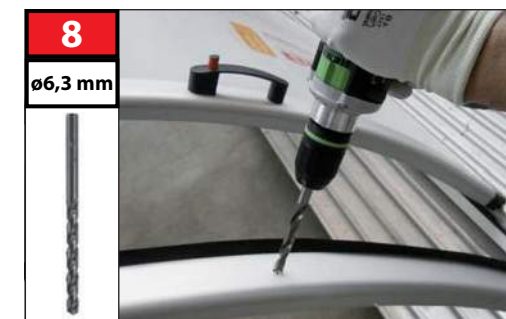
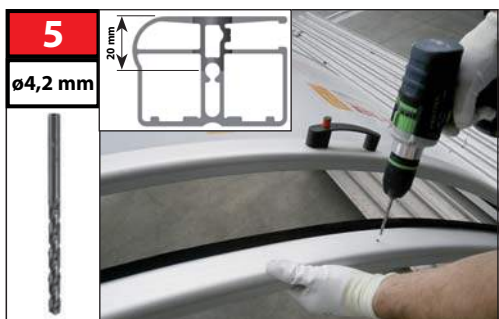

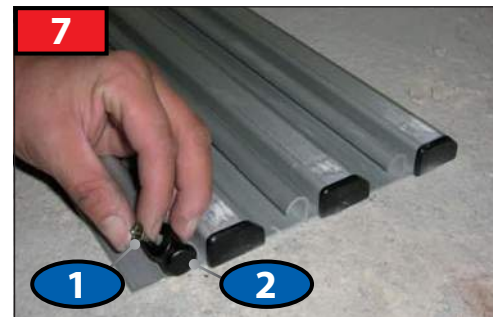
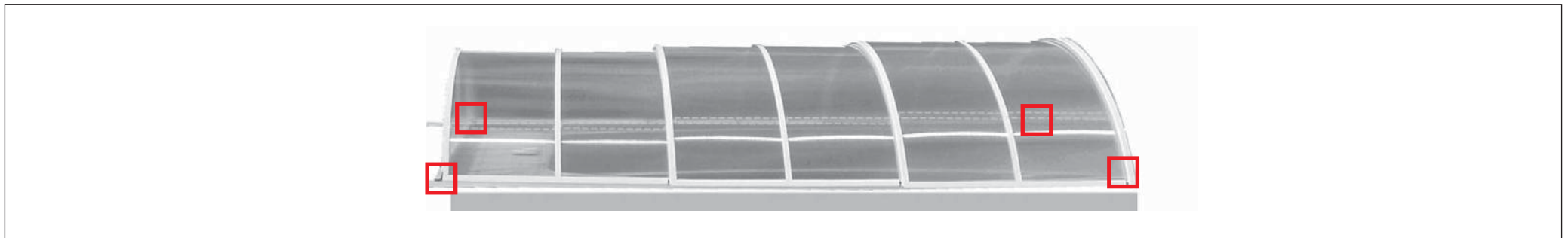
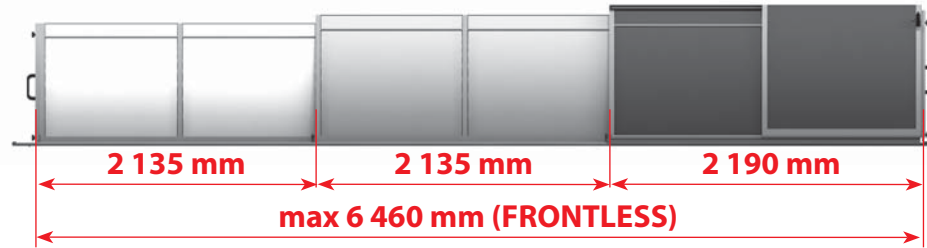

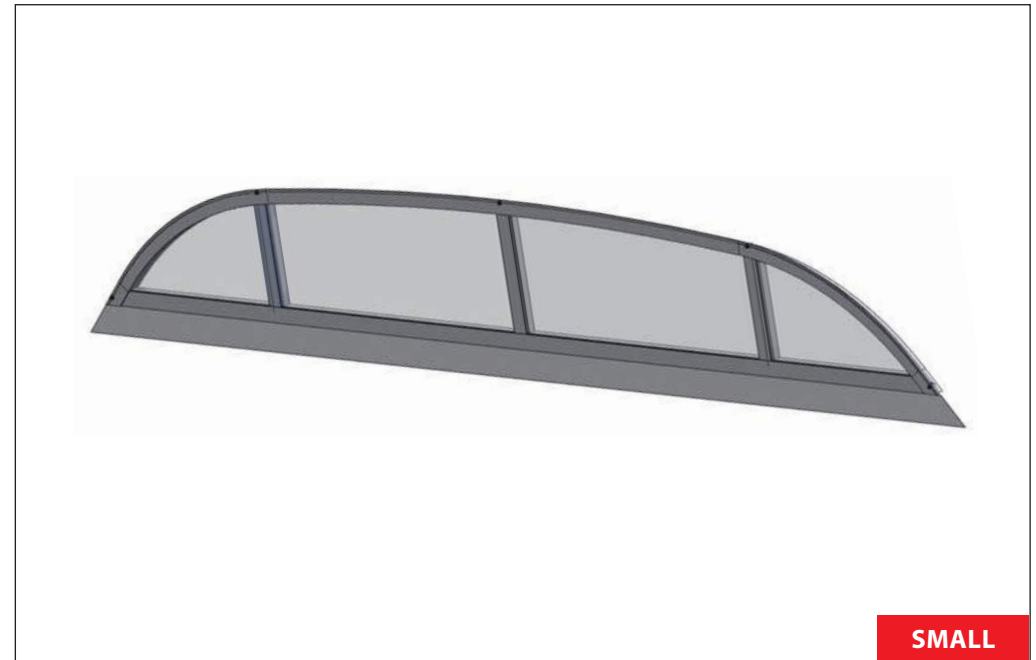
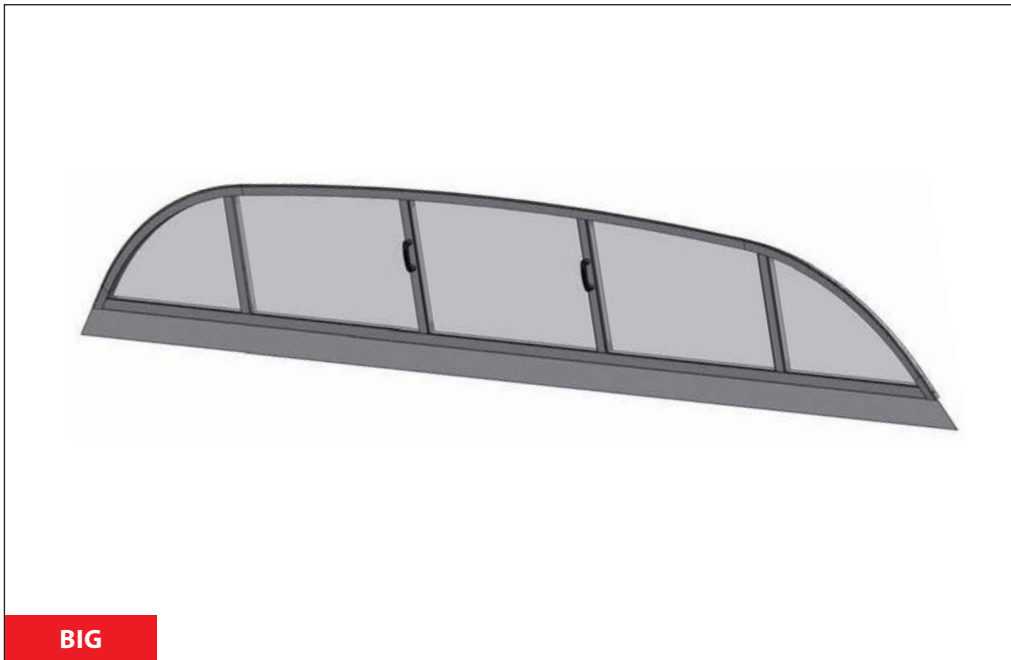
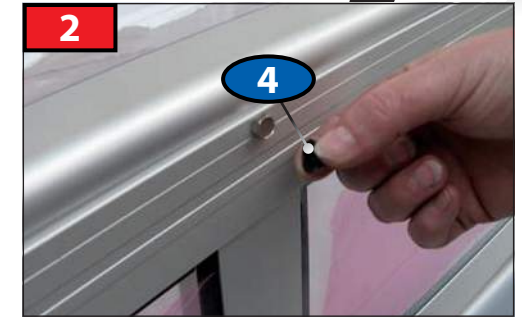

CZ

Dodavatel si vyhrazuje právo na změny a úpravy technických parametrů uváděných v tomto katalogu s ohledem na technický vývoj a zdokonalení výrobků a balení.
Dodavatel si vyhrazuje právo na tiskové chyby a chyby v sazbě.

DE

Der Lieferant behält sich das Recht auf Änderungen und Anpassungen der technischen Parameter, die in diesem Katalog aufgeführt sind, mit Rücksicht auf die technische Entwicklung und Verbesserung der Produkte und Verpackung vor. Der Lieferant behält sich das Recht auf Druckfehler und Fehler im Satz vor.

EN

The supplier reserves the right for modifications and adaptations of the technical parameters stated in this catalogue, considering the technical development and upgrade of the products and packaging. The supplier reserves the right for print errors and typographical errors.

ES

El proveedor se reserva el derecho de hacer cambios y modificaciones técnicas de los parámetros que figuran en este catálogo, con respecto al desarrollo técnico mejorando los productos y embalajes. El proveedor se reserva también el derecho a errores de impresión y composición.

FR

Le fabricant se réserve le droit de modifier les paramètres techniques cités dans ce manuel en considération du développement technique et de l'amélioration des produits et de leur emballage. Le fabricant se réserve le droit des fautes d'impression et de composition.

HU

Gyártó fenntartja jogát a katalógusban feltüntetett műszaki paraméterek változtatására a termékek és csomagolás technikai fejlesztése és tökéletesítése szerint.
Szállító: a szállító fenntartja jogát a nyomtatási és szedési hibákra.

IT

Il fornitore si riserva il diritto di effettuare modifiche e correzioni ai parametri tecnici riportati nel presente catalogo per migliorare e perfezionare dal punto di vista tecnico i prodotti e gli imballaggi. Il fornitore non esclude inoltre l'eventuale presenza di errori di stampa e di impaginazione.

PL

Dostawca zastrzega sobie prawo do zmian oraz dostosowania parametrów technicznych podanych w niniejszym katalogu z uwzględnieniem rozwoju technicznego i udoskonalania produktów oraz opakowań. Dostawca zastrzega sobie prawo do błędów druku oraz typograficznych.

PT

O provedor reserva-se o direito a efectuar alterações e adaptações de parâmetros técnicos mencionados neste catálogo, tendo em consideração o avanço técnico e melhorias de produtos e embalagens. O provedor reserva-se o direito a cometer erros de impressora e de edição.

RO

Furnizorul își rezervă dreptul de a modifica și schimba parametrii tehnici menționați în acest catalog cu privire la evoluția tehnică și perfecționarea produselor și a ambalării. Furnizorul își rezervă dreptul la greșelile de tipar și greșelile privind tarifele.

RU

Поставщик оставляет за собой право на изменение и исправление технических параметров продукции указанной в этом каталоге, с учетом технического развития, а усовершенствования изделий и его упаковки. Поставщик оставляет за собой право на опечатку в тексте и в ценах.